

The Effectiveness of Learning by PBL Assisted Mathematics Pop Up Book Againsts The Spatial Ability in Grade VIII on Geometry Subject Matter

by 63 Wardono

Submission date: 15-Apr-2023 05:02AM (UTC+0700)

Submission ID: 2064802209

File name: 63.pdf (1.34M)

Word count: 4857

Character count: 25223

¹⁴
**The Effectiveness of Learning by PBL Assisted Mathematics Pop Up Book Againsts
The Spatial Ability in Grade VIII on Geometry Subject Matter**

Scolastika **Mariani**¹, Wardono², Elyn Diah Kusumawardani³

⁴
⁴¹Lecturer at Study Program of Mathematics Education, Faculty of Mathematics and Science, Semarang State
University, Semarang, Indonesia

⁴²Lecturer at Study Program of Mathematics Education, Faculty of Mathematics and Science, Semarang State
University, Semarang, Indonesia

⁴³Student at Study Program of Mathematics Education, Faculty of Mathematics and Science, Semarang State
University, Semarang, Indonesia

e-mail: scmariani.unnes@gmail.com

²**Abstract**

The aim of this study was to know the effectiveness of learning by Problem Based Learning (PBL) assisted Mathematics Pop Up Book againsts the spatial ability in grade VIII on geometry subject matter. The population of this research was students grade VIII in junior high school 1 Salatiga academic year 2013/2014, and as the sample taken from two classes randomly, one class as the experiment class (PBL assisted Mathematics Pop Up Book), and another class as the control class (expository). Data of the research is analyzed according to the purpose of the research using proportion test and equality test on similarity of two average: one party (right). The result of the research shows (1) Mathematics Pop Up Book is combination of student books and props mathematics. Pop-up book used at the stage of concept explanation and application of concepts through exercises. Overall the use of pop-up book done in groups. The result of questionnaire about Mathematics Pop Up Book is very good. (2) Test result of the spatial ability on the students in experiment class has reached classical completeness criteria. (3) The spatial ability in experiment class students is higher than control class, and (4) The percentage of students' interest towards learning mathematics in experiment class is higher than control class. In conclusion, PBL assisted Mathematics Pop Up Book is effective againsts the spatial ability in grade VIII on the geometry material.

Key Words : PBL, Mathematics Pop Up Book, Spatial Ability

Introduction

Geometry is one of the material that is taught to students at all levels of education. However, students still has difficulty in learning geometry. This can be seen from the results of National Examination¹⁹ math for junior high school year 2011/2012, showed that¹⁹ student ability in math, especially surface area of space figure is low. In Salatiga, average value of the surface area of space figure is 27,34, while in Central Java province and nationally are 29,91 and 31,04. This is the lowest number than the other materials that have been tested. In preliminary tests of spatial ability that have been conducted in two class from Junior High School 1 Salatiga, showed that spatial ability of the students is low. Average value from this test that can be achieved by the student are 57,31.¹⁵

Prabowo & Ristiani (2011) said that problems related to the geometry in school caused by the level of object geometric abstraction is high and ability to visualize abstract objects (spatial ability) is low. Spatial ability is ability to capture the space world appropriately or the other word ability to visualize images (Gardner,¹⁸ Jam Harmony & Theis: 2012). Maier (1998) mention the five elements of the spatial ability is: (1) spatial perception, (2) spatial visualization, (3) mental, (4) Spatial relations, and (5) spatial orientation.

Development of learning media is necessary to do continually, follow the students' needs and progress of the times. The challenge at present is to make interesting learning media and must be practical and educational. One of media which can answer this challenge is pop-up book. Dzuanda, in Rahmawati (2012), explain that Mathematics Pop Up Book is a book that has movable parts or has a 3-D elements. In this research Mathematics Pop Up Book is combination of student book¹¹ and props mathematics. Blumel and Taylor, in Rahmawati (2012), said that the¹¹ usefulness of the pop-up book is: (1) to develop a love of books and reading for children, (2) to bridge the relationship between real life situations and symbols that represent them, (3) Mathematics Pop Up Book can develop critical thinking and creative thinking for student, and (4) Mathematics Pop Up Book can help students to grasp the meaning of the lesson and Mathematics Pop Up Book can bring the des⁸ to read independently.

Problem Based Learning (PBL) is one of learning models which used contextual problem as a context for students to learn about problem solving thinking (Arends, 2008). Awang (2008) said that "Problem-based learning (PBL) is one of the student centered approaches and has been considered⁷ by a number of higher educational institutions in many parts of the world as a method of delivery." The problem based learning model turns the student from passive information recipient to active, free self-learner and problem solver, and it slides the emphasis of educational programs from teaching to learning. (Akınoğlu & Tandoğan: 2007). Interest in the model PBL is quite extensive. This model is based on the principles of a solid theoretical and basic research of PBL was sufficient to support its use. Moreover, there is a large enough enthusiasm among teachers and students towards this model. PBL is becoming an attractive alternative for teachers who want to reach further beyond approaches based on teacher to challenge students with active learning aspect of this model (Arends, 2007).

Based on this background, the problems of this research are: (1) How utility of Mathematics Pop Up Book in problem based learning subject matter is geometry?; (2) is the number of spatial

ability that get the PBL model assisted by Mathematics Pop Up Book on geometry subject matter reaching the classical completeness criteria; (3) is the spatial ability that get the PBL model assisted by Mathematics Pop Up Book better than spatial ability that get the expository learning?; and (4) is the percentage of students' interest towards learning mathematics that get the PBL model assisted by Mathematics Pop Up Book better than percentage of students' interest towards learning mathematics that get the expository learning.

The aim of this study was to know the effectiveness of learning by PBL assisted Mathematics Pop Up Book against the spatial ability in grade VIII on subject matter is geometry.

Methodology

This research is experimental research. Experiments were conducted in this study is the application of PBL assisted Mathematics Pop Up Book in mathematics to determine spatial ability students. Two groups of samples were determined to get a different treatment according to the predefined variable. After receiving treatment, the two groups of samples given a post-test to compare the spatial ability between the experiment class and the control class.

The research population was the students of grade VIII of Junior High School 1 Salatiga 2013/2014 academic year which consists of 9 classes with a total population is 234 students. The research sample groups which taken by using random class sampling were class VIII E as the control class, class VIII G as the experimental class and class VIII C and VIII D as the trials instrument class. In control class, student get the expository learning model or in other words are not given special treatment (Z). In experiment class, student get the PBL model assisted by Mathematics Pop Up Book (X). Then at the end of the lesson the sample groups were given a spatial ability test (post test: O) with the same instrument. The research design in this study include true experiment design type posttest only control design, shown in Table 1.

Tabel 1. Research design: true experimental design type posttest only control design

Class	Treatment	Post test
Experiment	X	O
Control	Z	O

Methods of data collection used tests and questionnaires. Test method used is a description test as post test. Questionnaires were used aims to determine students' interest in mathematics learning activities and student responses to the pop-up book. To obtain valid test data, test instruments that meet the required validity, reliability, level of difficulty, and different power test.

Data were analyzed in two stages. First, initial stage of data analysis used normality test, homogeneity test and t-test. Second, to test the hypothesis include used normality test for final stage of data, homogeneity test for final stage of data, test mastery learning on students' spatial ability tests, and one tail t-test between experiment class and control class.

Result and Discussion

Learning process in this research have been done on 17 April 2014 until 3 May 2014 in Junior High School 1 Salatiga. Implementation of student learning in experiment and control class each held five meetings, with one meeting is two hours of lessons. Four meetings are used for learning and one meeting is used to test the ability of spatial as well as student interest questionnaire.

Based on the initial stage of data analysis, gained conclusion from the test of normality that the data is normal distributed. Based on the initial stage of data analysis, gained conclusion from the homogeneity test and t-test that the data is homogenous and no mean difference. This is mean the condition of the samples are same which mean the samples have same ability

After analyzing the initial data, given different treatment for each group of samples. In experiment class given PBL learning assisted by Mathematics Pop Up Book while in control class given expository learning. After the treatment of the samples, gained final data i.e. the result of post test of spatial ability of the samples, the result of questionnaire about interest in learning, and the result of questionnaire of experiment class about Mathematics Pop Up Book.

Gained the mean 91,4 of the result of questionnaire about Mathematics Pop Up Book. The category of that result is very good. Those information show that students in experiment class have good response against Mathematics Pop Up Book.



Picture 1. Mathematics Pop Up Book

The result of post test of spatial ability and the result of questionnaire of student's interest in learning are shown in Graphic 1.

Graphic 1. The result of spatial ability test and questionnaire of student's interest in learning

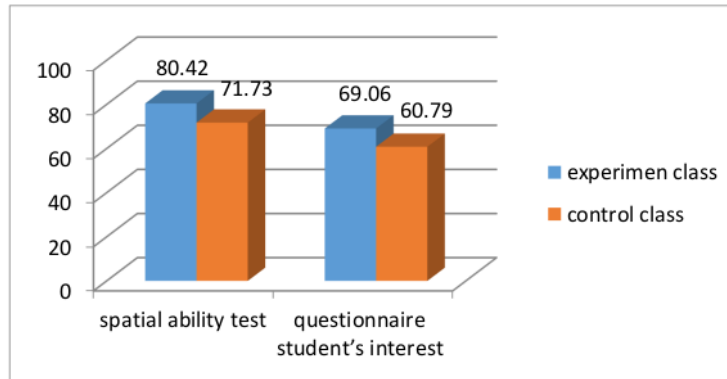

¹⁰ Based on the final stage of data analysis i.e. the result of the test of spatial ability in experiment and control class also the result of the questionnaire about student's interest in learning show that the data is normal and homogenous. After that, the data of spatial ability and the questionnaire about student's interest in learning are analyzed to prove the hypothesis.

Based on spatial ability score known that student's spatial ability who given PBL learning assisted by Mathematics Pop Up Book are pass classically. The score limit to pass individually the test (KKM) is 65 and at least 75% of students pass the test to pass classically. The data is analyzed by one-tail proportion test to know whether the class is pass classically or not. From the calculation of proportion test, gained $z = 0,6794$ and $z_{0,5-\alpha} = 1,64$. It is obvious that $z > z_{0,5-\alpha}$ so that H_0 is accepted which mean the proportion of student's spatial ability reach 75%. The number of students who pass the test is 21 out of 26 students. Based on the calculation, 80,77% of students pass the test. This information show that students in experiment class could pass the test classically and individually. The conclusion is in the class given by PBL learning assisted by Mathematics Pop Up Book could pass classically and individually.

⁹ Based on calculation through the one tail t-test, the score of student's spatial ability in the experiment class and the control class gained $t = 2,1326$ and $t_{1-\alpha} = 2,0086$. This is obvious that $t > t_{1-\alpha}$ which mean H_0 is denied. This is mean the mean of student's score of spatial ability of experiment class is better than control class. This information show that after different treatment both experiment and class control, the student's spatial ability in experiment class is better than the student's spatial ability in control class. The conclusion is the student's spatial ability with PBL learning assisted by Mathematics Pop Up Book is better than the student's spatial ability with expository learning.

Comparison between experiment and control class based on indicators of spatial ability shown in Table 2.

Table 2. The Comparison of Student's Spatial Ability

Indikator	Experiment class (%)	Control class (%)
<i>Spasial perception</i>	87,31	70
<i>Spasial visualitation</i>	96,15	93,59
<i>Mental rotation</i>	85,77	71,15
<i>Spasial relation</i>	64,76	59,80
<i>Spasial orientation</i>	93,27	89,74

From the Table 2, it is shown that student's spatial ability in experiment class is better than the control class in every indicator of spatial ability. The spatial visualization is the highest percentage among the indicators in both experiment and control class while the spatial relation is the lowest percentage among the indicators. However, the spatial ability could be improved by the doing the exercises. This is same as the result of research of Sorby (2007:9) which is by improving and applying the exercises will help the students improve their spatial ability. Here are some of student's result in spatial perception indicator.

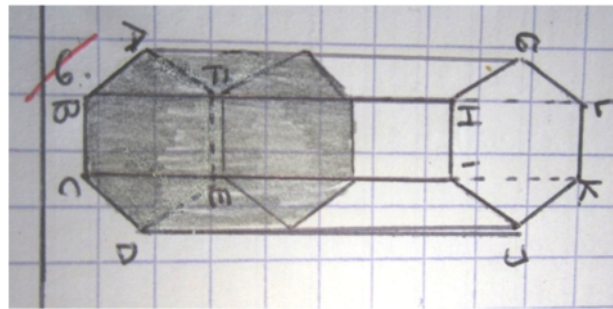

(a). Wrong answer

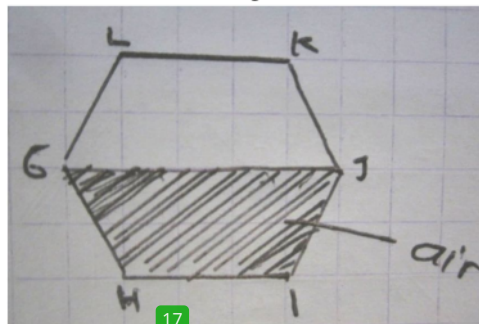

(b). Right answer

Picture 2. Student's result in spatial perception indicator

Student's interest in mathematics learning in both experiment and control class is known by the percentage of the mean of the interest score. From the percentage of the mean of interest score in each class, there is a different between student's interest in learning in both class. In experiment class, the mean of score is 69,06% while the control class is 60,79%. Although both class in the

same category of interest, yet there is a difference between the mean score of interest significantly. This is proved by the result of the calculation of one tail t-test student's interest in learning in both experiment and control class, gain $t = 2,7316$ and $t_{1-\alpha} = 2,0086$. This is show that $t > t_{1-\alpha}$ so that the H_0 is deined which mean the mean of student's interest in learning score in experiment class is greater than the mean of student's interest in learning score in control class. This information show that after given by different treatment in both class, student's interest in learning in experiment class is better than the control class. This is conclude that student's interest in learning with PBL learning assisted by Mathematics Pop Up Book is better than the student's interest in learning with expository learning.

The application of PBL learning assisted by Mathematics Pop Up Book in experiment class is done by the appropriate phases. The phases in PBL learning assisted by Mathematics Pop Up Book are as follows.

(1) Phase 1: to give the orientation about the problem to the students

In this phase, the teacher tell the purpose of the learning and motivate the student to be involved in problem solving.

(2) Phase 2: to organize the students to do the research.

In this phase, the teacher divide the number of students to several group. Then the teacher share the Mathematics Pop Up Book to each group to discuss.

(3) Phase 3: to help the investigation individually and by groups

In this phase, firstly the teacher provide the problems in the Mathematics Pop Up Bookclassically. The problem is used to construct the concept about the given material. In Mathematics Pop Up Book, the problem are exist in page 2, 7, 10, and 13. The activity is being continued by the teacher guiding the students to write the known from the problems. The writing of the information gained from the problem helps the students understand the problem and helps the students make a plan to solve the problems. Thhe teacher then guide the students classically to find the concepts to solve thte problem. These concepts can be found in Mathematics Pop Up Book page 3, 4, 5, 8, 11, and 14. The activity is being continued by the students do the plan to solve the problem with the help of the concepts. The teacher guide the students to discuss in their own group.

(4) Phase 4: to improve and to present the artifak and exhibit.

in this phase the teacher ask for one of student's group to present their result in front of the class

(5) Phase 5: to analyze and to evaluate the progress of problem solving

in this phase, the teacher guide the students to do the reflection of the activity and all the progress they do.

The application of PBL learning assisted by Mathematics Pop Up Book in experiment group is appropriate by the mental improvement in geometri learning as Van Hiele does are as follows.

(1) Visualization phase

This phase was happening in the first meeting i.e. when the introducing of the shape of prism in real life also introducing the kinds of prism. Provided in Mathematics Pop Up Book in the first problem at page 2and kinds of prism at page 3. In this phase, the students start to learn about

the shape in geometri, a prism yet the students do not know about the properties of those shape they see.

(2) Analyzing phase

this phase was happening in the first meeting i.e. the identification about the properties and the elements of prism. Provided in Mathematics Pop Up Book at page 4 and 5. This phase, the students start to know the properties that prism has. The students can tell the regularity of those shape yet the students do not know about the connection among those shapes.

(3) Ordering phase

This phase was happening at the second meeting i.e. when the identification of the nets of prism. Provided in Mathematics Pop Up Book at page 8. In this phase, the students can do the conclusion of the problem. We called this deductive thinking yet this ability could not improve at this research. One thing to know taht the students could identify the nets of prism orderly.

(4) Education phase

This phase was happening in third and fourth meeting i.e. when the students found the formulas of the surface area and the volum of prism. Provided in Mathematics Pop Up Book at page 11 and 14. In this phase, the students know to make a conclusion deductively i.e. the conclusion about things that apply in general to the specific things. The students do understand the formulas of planes and also the formulas of blok yet the students do not connect those thing with the proving the formulas of the surface area and volume of prism.

(5) Accuracy phase

accuracy phase is a phase to think higher, complicated, and complex. This phase was happening in third and fourth meeting i.e. when the students find the formulas of the surface area and volum of prism. Provided in Mathematics Pop Up Book at page 11 and 14. The students could connect their knowledge of area of planes and also the formulas to find the volum of blok figure to proving the formulas of surface area and volum of prism.

During the PBL learning assisted by Mathematics Pop Up Book, the students are more active in learning progress. This was caused by the students were invited to discuss and work together in groups. Work as a group, the students share their own opinion and knowledge about the problem they are facing with.

The used of Mathematics Pop Up Book in the process of learning is causing the students become more enthusiastic to learn. During of learning there are many students were flipping the Mathematics Pop Up Book actively to see what material will be taught or to find the hidden answer in the problem sheet. The enthusiasm against Mathematics Pop Up Book also shown by the response of one of the students who want make other Mathematics Pop Up Book by himself.

At control class given by expository learning yet the teacher is more active as informer so that the material of the learning is from the teacher himself/herself not the students. The students become more passive in the learning due to the learning itself become teacher-centered. The problems faced by the students of control class is about the ability to understand the material and solve the question. The students tend to work and think individually. This will cause the students be independent yet there will be less improving ideas compare with the discussion with friends. The control class did not use the Mathematics Pop Up Book as the experiment class did. This make

those students had difficulty to solve the problem with spatial ability. A method needed in learning to improve student's spatial ability.

Conclusion

Based on the result of research about effectiveness of learning by PBL assisted Mathematics Pop Up Book againts the spatial ability in grade VIII on geometry subject matter , gained the conclusion that. (1) Mathematics Pop Up Book is combination of student books and props mathematics. Pop-up book used at the stage of concept explanation and application of concepts through exercises. Overall the use of pop-up book done in groups. The result of questionnaire about Mathematics Pop Up Book is very good. (2) Test result of the spatial ability on the students in experiment class has reached classical completeness criteria. (3) The spatial ability in experiment class students is higher than control class, and (4) The percentage of students' interest towards learning mathematics in experiment class is higher than control class. Thus, it can be said that PBL learning assisted by Mathematics Pop Up Book is effective against student's spatial ability in grade VIII on geometry subject matter .

Based on that conclusion, the researcher recommend to (1) the mathematics teacher may use PBL learning assisted by Mathematics Pop Up Book as an alternative learning to improve student's spatial ability and student's interest in learning, (2) PBL learning assisted by Mathematics Pop Up Book is proved and effective against student's spatial ability in prism learning material so that need an improvement to make this learning able to be used in another geometry material.

References

- Akınoğlu, O. & Tandoğan, R. O. 2007. *The Effects of Problem-Based Active Learning in Science Education on Students' Academic Achievement, Attitude and Concept Learning*. Eurasia Journal of Mathematics, Science & Technology Education, 3(1), 71-81. Tersedia di <http://www.ejmste.com/> [diakses pada 16-01-2014].
- Arends, R. I. 2008. *Learning to Teach: Belajar untuk Mengajar* (7th ed). Buku dua. Translated by Soetjipto, H.P & S. M. Soetjipto. 2008. Yogyakarta: Pustaka Pelajar.
- Awang, H. & Ramly, I. 2008. *Creative Thinking Skill Approach Through Problem-Based Learning: Pedagogy and Practice in the Engineering Classroom*. International Journal of Human and Social Sciences 3:1.
- Harmony, J. & R. Theis. 2012. *Pengaruh Kemampuan Spasial Terhadap Hasil Belajar Matematika Siswa Kelas Vii Smp Negeri 9 Kota Jambi*. Online. Tersedia di <http://online-journal.unja.ac.id/> [diakses pada 04-02-2014].

- Maier, P.H. 1998. *Spatial Geometry and Spatial Ability-How to make solid geometry solid?*. p.63-75. Tersedia di <http://www.fmd.uni-osnabrueck.de/ebooks/gdm/PapersPdf1996/Maier.pdf> [diakses 30-01-2014].
- Prabowo, A. & E. Ristiani. 2011. *Rancang Bangun Instrumen Tes Kemampuan Keruangan Pengembangan Tes Kemampuan Keruangan Hubert Maier dan Identifikasi Penskoran Berdasar Teori Van Hiele*. Online. Tersedia di <http://kreano.unnes.ac.id/> [diakses pada 13-01-2014].
- Rahmawati, N. 2012. *Pengaruh Media Pop-up Book Terhadap Penguasaan Kosakata Anak Usia 5-6 Tahun di TK Putera Harapan Surabaya*. Online. Tersedia di <http://ejournal.unesa.ac.id/article/9458/19/article.pdf> [diakses 04-02-2014].
- Sorby, S.A. 2007. *Developing 3D Spatial Skills for Engineering Students*. Australasian Journal of Engineering Education, Vol 13 No 1: 1-11.

Attachment 1.

MATHEMATICS POP UP BOOKS



Purpose of the study



Problems 1: definition of prism



Display of prism elements



Problems 3: surface area of a prism



Problems 4: the volume of prisms



Students used a pop-up book for discussion groups

Attachment 2.

KISI - KISI SOAL TES KEMAMPUAN KERUANGAN**Sekolah** : SMP Negeri 1 Salatiga**Kurikulum** : KTSP**Mata Pelajaran** : Matematika**Alokasi Waktu** : 60 menit**Kelas / Semester** : VIII / Genap**Jenis Soal** : Uraian**Standar Kompetensi** : 5. Memahami sifat-sifat kubus, balok, prisma, limas, dan bagian-bagiannya, serta menentukan ukurannya.

Kompetensi dasar	Materi	Indikator Soal	No Soal	Bentuk Soal	Indikator Kemampuan Keruangan
5.1 Mengidentifikasi sifat-sifat kubus, balok, prisma, dan limas serta bagian-bagiannya.		Siswa dapat menggambar tampilan gabungan beberapa prisma yang terlihat dari sisi depan dan sisi kiri pada pada bidang datar.	2	Uraian	<i>Spatial Orientation</i>
5.2 Membuat jaring-jaring kubus, balok, prisma dan limas	Prisma	Siswa dapat menggambar tiga buah jaring-jaring yang berlainan dari prisma yang diketahui.	1	Uraian	<i>Spatial Visualization</i>
5.3 Menghitung luas permukaan dan volume kubus, balok, prisma dan limas.		Siswa dapat menghitung volume prisma yang telah dirotasi.	4	Uraian	<i>Mental Rotation</i>

Attachment 3.



**KEMENTERIAN PENDIDIKAN DAN KEBUDAYAAN
UNIVERSITAS NEGERI SEMARANG**

FAKULTAS MATEMATIKA DAN ILMU PENGETAHUAN ALAM

Gedung D Kampus Sekaran Gunungpati Semarang Kode Pos 50229 Telp. (024) 8508112

Website : <http://mipa.unnes.ac.id> , Email : mipa@unnes.ac.id

SOAL TES KEMAMPUAN KERUANGAN

Mata Pelajaran : Matematika

Kelas/Semester : VIII/Genap

Materi Pokok : Prisma

Waktu : 60 menit

Petunjuk:

1. Berdoalah terlebih dahulu sebelum mengerjakan.
2. Tulislah identitas dengan lengkap pada lembar jawaban.
3. Kerjakan soal menggunakan pulpen atau pensil dilembar jawab yang tersedia.
4. Kerjakan terlebih dahulu soal yang Anda anggap mudah.
5. Periksa kembali pekerjaan Anda sebelum diserahkan kepada pengawas.

Jawbalah pertanyaan-pertanyaan berikut ini dengan jelas dan cermat!

1. Gambarlah 3 jaring-jaring prisma dari prisma tegak segitiga ABC.DEF, dengan pola yang berlainan serta dilengkapi dengan keterangan hurufnya!

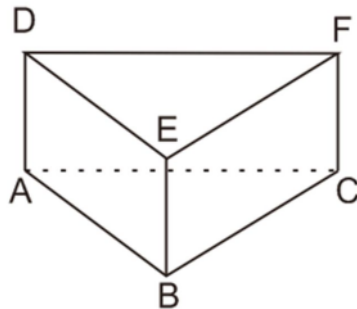

Soal no. 2 dan 3.

Sebuah maket disusun dari beberapa prisma seperti gambar dibawah ini.

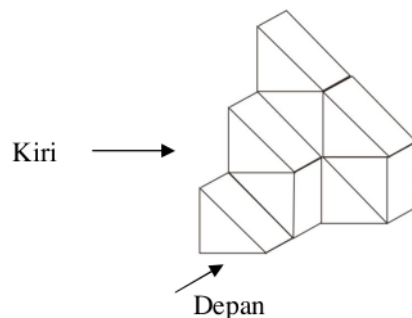

2. Gambarlah bentuk bangun ruang tersebut dalam bidang datar jika dilihat dari sisi depan dan sisi kiri!
3.
 - a. Berapa banyak prisma yang dibutuhkan untuk membuat maket tersebut?
 - b. Jika semua permukaan maket dicat (kecuali bagian alas), berapa banyak sisi prisma yang tidak tercat?
4. Berikut adalah gambar prisma segitiga beraturan.

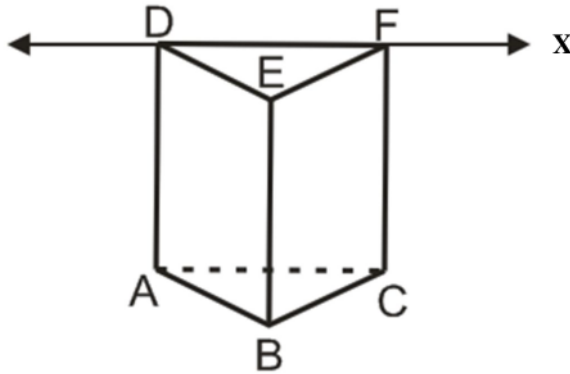

- a. Gambarkan prisma ABC.DEF jika diputar ke arah depan di sumbu X dengan sudut 180° !
 - b. Hitung volume prisma ABC.DEF jika panjang alas, tinggi alas, dan tinggi prisma adalah 4 cm, 6 cm, 17 cm!
5. Berikut adalah gambar sebuah balok yang terdapat prisma tegak segitiga didalamnya. panjang balok = 15 cm, lebar balok = 4 cm dan tinggi balok = 6 cm. Tinggi dan lebar alas prisma sama dengan tinggi dan lebar balok, sedangkan panjang alas prisma = 5 cm. Jika pada balok tersebut akan dimasukkan air, maka berapakah volume air yang dapat masuk kedalam balok tersebut?

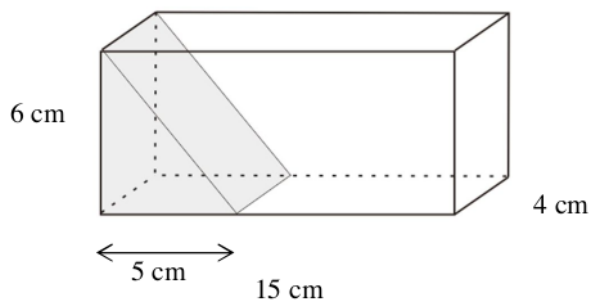

6. Sebuah prisma tegak ABCDEF.GHIJK diisi air setengah bagian. Gambarkan posisi air yang terlihat dari posisi depan, jika prisma tersebut diputar kedepan dengan poros sumbu X sebesar 90° !

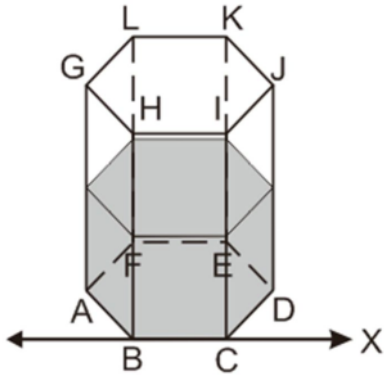

7. Gambar dibawah ini merupakan gambar prisma tegak segilima beraturan dilihat dari sisi yang berbeda. Hitung luas sisi prisma yang memiliki warna biru?

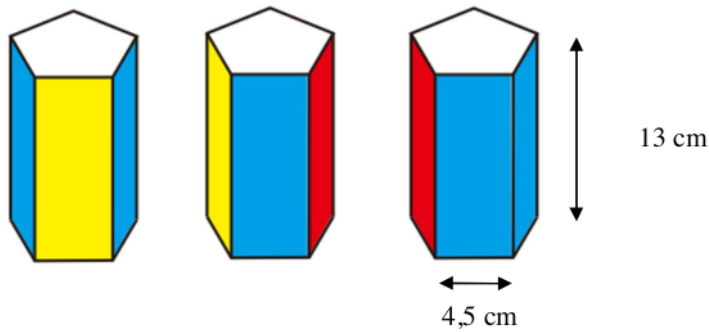

Attachment 4.

DESCRIPTIVE ANALYSIS OF SPATIAL ABILITY TEST RESULTS

Description	Experiment Class	Kontrol Class
number of students	26	26
The maximum value	100	89
The minimum value	43	40
Average	80,42	71,73
Variance	250,12025	181,4328
Standard deviation	15,82	13,47

Attachment 5.

PHOTOS OF THE STUDENT'S WORK

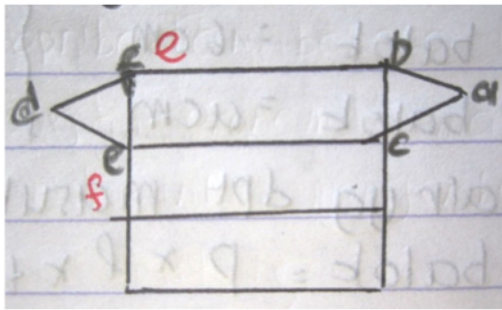

The weakness of the indicator
Spatial Visualitation

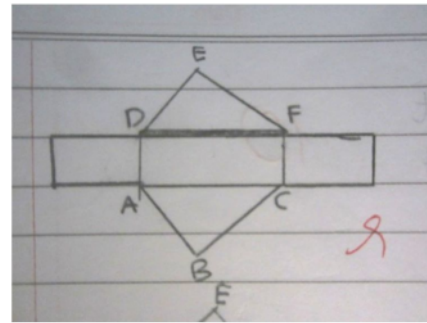

Results of Student's Work on indicators
Spatial Visualitation

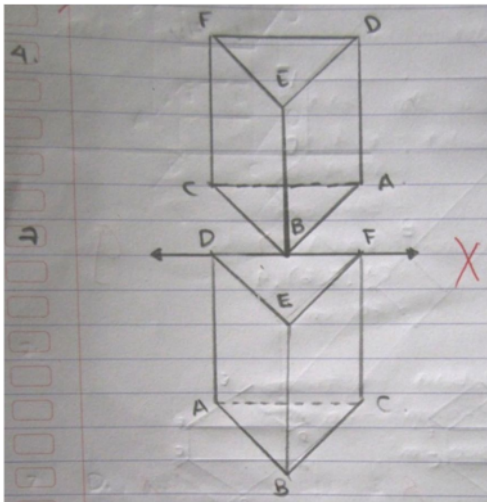

The weakness of the indicator
Mental Rotation

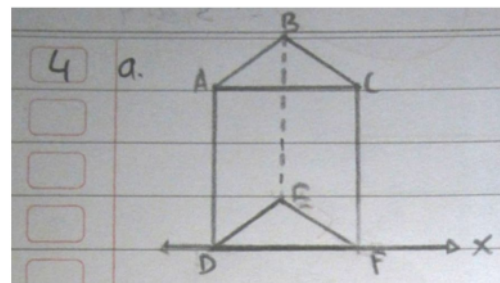

Results of Student's Work on indicators
Mental Rotation

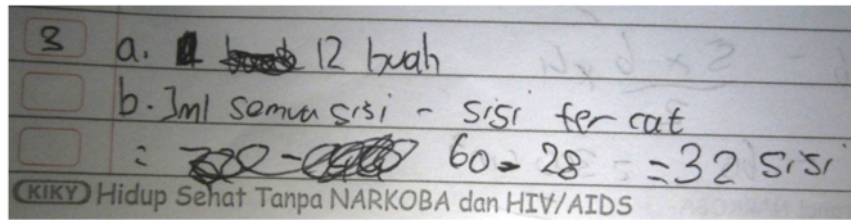

Results of Student's Work on indicators *Spatial Relation*

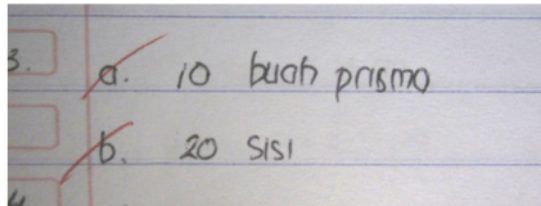

The weakness of the indicator *Spatial Relations*

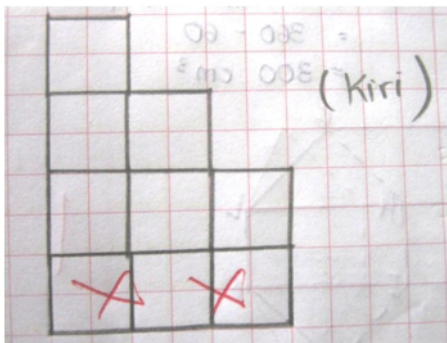

The weakness of the indicator *Spatial Orientation*

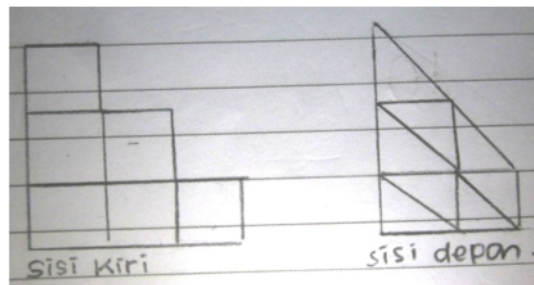

Results of Student's Work on indicators *Spatial Orientation*

The Effectiveness of Learning by PBL Assisted Mathematics Pop Up Book Againsts The Spatial Ability in Grade VIII on Geometry Subject Matter

ORIGINALITY REPORT

17%

SIMILARITY INDEX

13%

INTERNET SOURCES

12%

PUBLICATIONS

8%

STUDENT PAPERS

PRIMARY SOURCES

1	Submitted to Hellenic Open University Student Paper	2%
2	digilib.unimed.ac.id Internet Source	2%
3	Dea Permatasari, E. W. Laksono. "Exploring Guided Discovery Learning: The Effect on Students' Integrated Ability and Self-Regulated in Chemistry", Journal of Physics: Conference Series, 2019 Publication	1%
4	text-id.123dok.com Internet Source	1%
5	Elita Zusti Jamaan, Diana Nomida, Zulfiarti Syahrial. "The impact of problem-based learning model and visual-spatial intelligence to geometry achievement of junior-high-school students", Journal of Physics: Conference Series, 2019 Publication	1%

6	Evita Anggereini, Mona Septiani, Afreni Hamidah. "Application of guided inquiry learning model in biological learning: it's the influence to science process skills and students 'scientific knowledge in class XI MIPA high school", Journal of Physics: Conference Series, 2019 Publication	1 %
7	Submitted to Argosy University Student Paper	1 %
8	www.iiste.org Internet Source	1 %
9	P. Nindy Citroresmi, Nurul Husna, Citra Utami, Mariyam, Rika Wahyuni, Andi Mursidi. "Chapter 17 Means Ends Analysis Learning Model on Students' Problem-Solving Ability and Creative Thinking Ability", Springer Science and Business Media LLC, 2022 Publication	1 %
10	repository.utp.ac.id Internet Source	1 %
11	Submitted to President University Student Paper	1 %
12	Richard E. Mayer, Valerie K. Sims. "For whom is a picture worth a thousand words? Extensions of a dual-coding theory of	1 %

multimedia learning.", Journal of Educational Psychology, 1994

Publication

13	journal.uad.ac.id Internet Source	1 %
14	sinta3.ristekdikti.go.id Internet Source	1 %
15	ww.w.ijern.com Internet Source	1 %
16	Hayaturrahmi, Khairil, Abdullah. "Enhancing students' biological diversity learning outcomes through video assisted problem-based learning", Journal of Physics: Conference Series, 2020 Publication	<1 %
17	mafiadoc.com Internet Source	<1 %
18	discovery.researcher.life Internet Source	<1 %
19	Dmitry Rykunov, András Fiser. "Effects of amino acid composition, finite size of proteins, and sparse statistics on distance-dependent statistical pair potentials", Proteins: Structure, Function, and Bioinformatics, 2007 Publication	<1 %

20

repository.iainpalopo.ac.id

Internet Source

<1 %

21

ijtmer.com

Internet Source

<1 %

Exclude quotes On

Exclude matches < 10 words

Exclude bibliography On