

# The spatial thinking process of the field-dependent students in reconstructing the geometrical concept

*by Mulyono Matematika*

---

**Submission date:** 03-Oct-2022 07:49AM (UTC+0700)

**Submission ID:** 1914720634

**File name:** Artikel\_IJERE\_2022\_Suryo\_Bintoro\_Sukes\_Mulyono\_Walid.pdf (434.72K)

**Word count:** 7413

**Character count:** 35412

## The spatial thinking process of the field-dependent students in reconstructing the geometrical concept

Henry Suryo Bintoro<sup>1</sup>, Yohanes Leonardus Sukestiyarno<sup>2</sup>, Mulyono Mulyono<sup>2</sup>, Walid Walid<sup>2</sup>

<sup>1</sup>Graduate School, Universitas Negeri Semarang, Semarang, Indonesia

<sup>2</sup>Department Faculty of Mathematics and Natural Science, Universitas Negeri Semarang, Semarang, Indonesia

### Article Info

#### Article history:

Received Jun 23, 2021  
Revised Jun 10, 2022  
Accepted Jun 30, 2022

#### Keywords:

APOS theory  
Field-dependent  
Geometry  
Spatial thinking

### ABSTRACT

Reconstructing geometrical concepts requires a spatial thinking process, so the spatial thinking process will be correct and complete. The phenomena of cognitive style differences cause different perceptions and thinking activities to solve geometric problems. This qualitative-exploratory research describes the spatial thinking process of students with field-dependent cognitive styles in reconstructing the concept of spatial geometry based on the theory of Action-Process-Object-Schema (APOS). The research subjects were 27 students and obtained five students with field-dependent cognitive styles. The researchers used a purposive sampling technique from the subjects with a certain consideration. The researchers selected a student that met the three elements of spatial thinking and the five indicators of spatial ability. This research collected the data with interviews, documentation, and group embedded figure test (GEFT). The analyzing techniques used data collection, data reduction, data presentation, and concluding. The spatial thinking process of the field-dependent students had a spatial category with three indications: i) Inaccuracy in the elements of representational thinking; ii) The inaccuracy of spatial perception indicators; and iii) Not using de-encapsulation mental mechanisms.

5  
This is an open access article under the [CC BY-SA](https://creativecommons.org/licenses/by-sa/4.0/) license.



### Corresponding Author:

Yohanes Leonardus Sukestiyarno  
Department Faculty of Mathematics and Natural Science, Universitas Negeri Semarang  
Kelud Utara III Street, Semarang 50237, Indonesia  
Email: sukestiyarno@mail.unnes.ac.id

## 1. INTRODUCTION

Geometry is a mathematics field of learning at the primary until university education levels. The reasoning and applied aspects of geometry play important roles in mastering science and technology [1]. Although this material exists in all education levels, it does not guarantee the learners will not commit any mistakes to answer the questions. Learning geometry challenges both teachers and learners. It requires an insightful thinking process effectively [2]. Geometry is important because the concept is connected to the environment and everyday life [3], [4]. The results showed that working on geometric questions still became a problem for learners. They made many mistakes [5]–[7]. The mistakes could be traced by analyzing their thinking processes. This notion is relevant with [8]. The study found that noticing the learners' thinking skill process could improve their thinking processes.

According to the experts, the most relevant thinking process to analyze geometric material is the spatial thinking process because of its importance in creating geometric problem representation [9]. Spatial thinking skill is useful to establish geometric conceptual understanding and mistakes in understanding geometry [10]–[12]. National Research Council explains the three sub-skills of spatial thinking. They are "spatial concept, representative means, and reasoning process" [13]. These elements should exist when the learners are solving geometric problems.

Spatial thinking allows recognizing and manipulating the object-spatial nature and the connection among the inter-object space [14]. Spatial thinking combines a set of different skills and multi-dimension nature. It requires understanding about spatial elements and involves spatial feature visualization mentally [15]. According to Maier [16], spatial skills have some indicators, such as “spatial perception, spatial visualization, thought rotation, spatial relation, and spatial orientation.” On the other hand, previous researchers [17] proposed the indicators are “mental rotation, spatial orientation, and spatial visualization.” This research used indicators of spatial ability, namely spatial perception, spatial visualization, mental rotation, spatial relations, and spatial orientation.

Experts found some ways to trace spatial thinking processes. One of them is the Action-Process-Object-Schema (APOS) theory. The thinking process is traced with the mental structural framework and mechanism in constructing the knowledge [18]. The results showed that the APOS theory could find the learners' thinking processes [19]–[21]. The APOS theory determines the learners' mathematics thinking reconstruction in geometric and algebraic concepts [22]–[24]. The applied theory could trace the thinking process, starting from the mental action structure, process, object, and scheme. The action deals with the mental thinking structure realized in trials, memory, and truth-rechecking of the constructed examples. The process deals with the thinking process established by the mental action interiorized mechanism while defining something. Object deals with the established mental structure and mental mechanism of the encapsulated process while applying the rules. Scheme deals with a set of actions, processes, and objects.

The thinking process has many factors. One of them is the cognitive style, a specific and unique way to see, understand, and process information. The cognitive process is exploratory from the cognitive styles. Every individual has a specific cognitive style as the personal character and potential adjustments to receive and process the information during learning.

The cognitive style also strongly influences mathematics problem solving, especially geometry. This finding was supported by previous research [25]. The study found that cognitive style influenced geometric learning outcomes. The students' cognitive style should be considered to improve their math problem-solving skills [26]. According to previous researchers [27]–[29], the cognitive style has two categories. They are field-dependent and field-independent cognitive styles. Students with cognitive style mostly have excellent language mastery, understanding, and inter-individual interaction. They rely on external references and the given materials for learning [30]–[32]. In this research, the researchers were interested in geometrical concept reconstruction of field-dependent students based on APOS. The research focus was the field-dependent cognitive style since students with this type had low spatial skills. The researchers explored the students' mistakes of spatial thinking process on the geometric problem. Then, the researchers would recommend a better learning improvement.

## 2. RESEARCH METHOD

This qualitative exploratory research allowed researchers to find the most appropriate objects. The researchers selected a subject based on three spatial thinking elements, geometrical conceptual reconstruction, and communicative communication. The subjects were 27 students of the Mathematics Education Department of Universitas Muria Kudus Indonesia. The researcher grouped the students with the embedded figure test into field-dependent, field-independent, and field-intermediate groups. The field-dependent group consisted of five students. The researcher took the subjects with purposive sampling. This sampling technique selects the subjects based on certain considerations. Then, the researchers selected two respondents based on the uniqueness of the answers and their communication skills. The students were interviewed with in-depth interviews. The researchers selected one of them to join an interview to discuss the occurring spatial thinking. The considerations to select one subject were the requirements of three spatial thinking elements and five spatial thinking indicators. The number of the subject was adequate and could represent the findings on students with field-dependent typed cognitive style. It was in line with some previous findings that the numbers of subjects, two, three, four, and five, could represent the research subjects [33]–[37].

The techniques to collect the data were interviews, documentation, and group-embedded figure test. In this case, the researchers were the main instruments. The supportive instruments were the geometric task documentation to determine the spatial thinking process, the group embedded figure test (GEFT) to find out the cognitive style, and interviews to check the works' correctness and trace the spatial thinking skills based on APOS. The task instrument consisted of five questions. It also used indicators, such as spatial perception, spatial visualization, mental rotation, spatial relation, and spatial orientation. The GEFT instrument is a standardized test developed by Witkin to determine the cognitive styles whether the learners are field-dependent or field-independent learners [38]. The test consisted of 25 questions. They were grouped into three sessions. The first group consisted of seven figures. The second session consisted of nine figures. Then, the third session consisted of nine figures. The students had to find the simple figures hidden in the

*The spatial thinking process of the field-dependent students in reconstructing ... (Henry Suryo Bintoro)*

large and complex figures. The interview consisted of 22 questions and used the structural and instrumental APOS framework indicators. They were action, process, object, and scheme.

In this research, the researcher used Miles and Huberman to analyze the data. According to previous studies [39], [40], the qualitative data analysis technique included data reduction, display, and verification. The data reduction stage consists of screening, simplifying, and focusing the interview result data and the task document analysis data based on the targeted objectives. The data display consisted of creating the correlation pattern to present the data in diagrams, tables, and narrations. The verification consisted of descriptions of the findings based on the collected data to determine field-dependent students' spatial thinking process types, both written and oral geometric tasks based on APOS theory.

### 3. RESULTS AND DISCUSSION

The GEFT results showed three groups of cognitive styles: field-dependent (FD), field-independent (FI), and field-intermediate or neutral as presented in Table 1. The table shows that five students are FD typed, 12 students FI, and 10 students neutral. The research focus only selected the subjects with FD typed cognitive style. Then, the students received a spatial thinking test on the positions of points, lines, and planes. The researchers interviewed them as the last stage with an in-depth interview.

Table 1. The students' cognitive style distributions

Total of the students	Cognitive styles		
	Field dependent	Field intermediate	Field independent
27 students	5 students	10 students	12 students

The subject (S) indicated the mental action structures by reading and understanding the questions. The subject identified the problem components in spoken mode. The subject indicated object shapes from each box. The subject determined the figure sketch, the distances among the lines, the point to the field, and a point to the line. The mental process structure of subject was the coordination process in a written task as shown in Figure 1. The subject coordinated the task with the interview, as shown in the excerpt (R=researcher and S=Subject).

R: What did you first do when you read the questions?

S: I understood the point of the question and noted the required information. Then, I sketched to make it clear and understandable before solving the problems.

R: After obtaining the information, what did you think?

S: I operated the information by transforming them into a sketch of a box net.

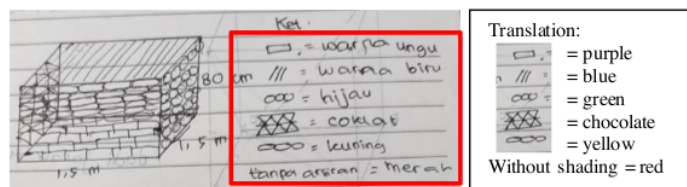
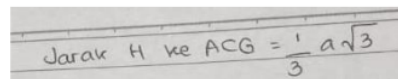

Figure 1. The subject coordination result by presupposing the box content

From the collected data, Figure 1 and interview, the subject had a written task coordination process. He presupposed the sides of three boxes with side symbolization. This action showed his spatial thinking process with correct conceptual understanding. The subject sketched the cat and hamster boxes. The cat box sketch looks complex. The sketch, written with symbols, is correct. In this case, only the subject understood the sketch. It proved he had corrected external representation. The subject determined the field-a point distance and vice versa correctly.

The subject also did the reversal process by remembering the comparison formula of spatial diagonal. This matter proved he did mental process structure. The comparison formula of the spatial diagonal length was recognized on the divider field. Then, he coordinated the interiorized components. Figure 2 shows the rehearsal process of the subject's written task.



Translation:  
 Distance H to ACG =  $\frac{1}{3} a\sqrt{3}$

Figure 2. The subject's rehearsal by comparing formula of the spatial diagonal length

According to the interview, the subject got the line of H to the middle point of ACG by multiplying the value with  $\frac{1}{3}$ . The subject argued that H - ACG was one-third of space diagonal. Figure 2 also proves the subject did the reversal process. The subject recalled the formula. Then, he sketched figures of the interiorized components. He realized the was also the distance. It proves the subject does the reasoning process briefly by recalling the previous knowledge. The subject took the process into an object, both written and spoken tasks. This process is an encapsulation process, as shown in Figure 3.

	
<div style="border: 1px solid black; padding: 5px;">                     Translation:                      Father:                      Red to yellow = beam width = 1.5 m = 150 cm                      Arfa:                      Red to yellow = block height = 0.8 m = 80 cm                      So, the case of the shorter distance of the red to yellow plywood belongs to Arfa = 80 cm &lt; 150 cm                 </div>	<div style="border: 1px solid black; padding: 5px;">                     Translation:                      Distance H to ACG = <math>\frac{1}{3} a\sqrt{3}</math>  <math>= \frac{1}{3} 40\sqrt{3}</math>  <math>= \frac{40}{3}\sqrt{3}</math>                      So, the distance H to ACG is <math>\frac{40}{3}\sqrt{3}</math> cm                 </div>
(a)	(b)

Figure 3. (a) Field to field distance determined by the subject and (b) The distance of a point to a field determined by the subject

In terms of mental encapsulation mechanism, the subject knew Arfa's cat box had the shortest distance, 80 cm. He also knew that the distance of H to ACG was  $\frac{40}{3}\sqrt{3}$  cm. The subject realized the correct line as the correct distance, the lateral of the cube. The subject used the formula of diagonal spatial comparison of a cube and found H to ACG with a value of  $\frac{1}{3}$  from the cube spatial diagonal length. It was  $\frac{40}{3}\sqrt{3}$  cm. The mental reversal structures of the subject were recalling the formula and determining the distance correctly. However, he did not do it in a complete process. It proved the subjects did the correct reasoning process.

The researchers found mistakes in the subject's encapsulation when he determined the distance from a point to a line as shown in Figure 4. The subject estimated P-AG from P to the center of AG. The subject made a simple sketch, although it was incorrect while determining the line of the P-AG distance. The subject thought the center point of the line AG was perpendicular with point P while the angle PAG was angular, but it was incorrect. The subject admitted he was doubtful, but he kept on what he thought. He could calculate correctly but, because of his mistake, his answer was incorrect. He made a mistake in the representation of thought. However, he did correctly while reasoning. It meant the subject could do the object-mental structure during the encapsulation process with an incorrect answer.

Then, the subject could promote thematization by identifying the problems correctly. Thus, he could correctly think of the spatial concept element. He brought the problems into an incomplete sketch, so there were some mistakes while determining the distance line. According to the interview result, the subject could understand that the distance was the segment length of both object connectors. It had a smaller value, and it was correct. His mistake was on the representation thinking. The subject drew a complicated or very modest sketch, but the reasoning process was incorrect.

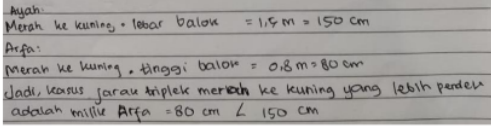
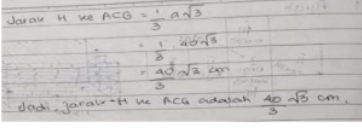

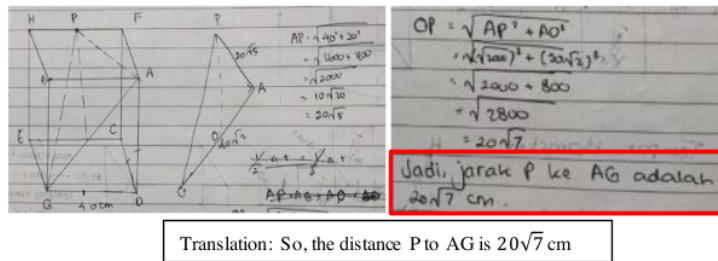

Figure 4. The subject determined the distance of a point to a line

The subject did oral thematization with the use of generalization. Figure 5 shows the analysis of the spatial concept, reasoning process, and external representation based on APOS. This figure explains the spatial thinking plots of field-dependent students. The tracing process of spatial thinking used APOS theoretical framework. It consisted of mental action, process, object, and scheme. The figure shows the subject uses all spatial thinking elements and five spatial thinking indicators, although the finishing stage is not accurate. Hence, the detail of Figure 5 is presented in Table 2.

Figure 5 and Table 2 show the mental action structure of the FD subject. He identified the demanded boxes and identified the lines as distances of a point to a point, a field, and a line. The interiorization in the action process was to imagine the solving stages implicitly [18]. It was in line with [41]. The study found that solving process was still inside of the mind. In this stage, the subject used his spatial thinking element correctly. The subject reached the spatial visualization indicator correctly. The spatial visualization involved the object image in the space of the object manipulation inside of the mind [42].

In the mental structure process, the subject did mental coordination mechanism and reversal coordination by presupposing the cat box sides. However, he did not presuppose the hamster box sides. Then, S sketched cat and hamster boxes accurately. The subject determined the connection of lines. He identified the distances of a point to a point, a point to a field, and a point to a line. The subject did the reversal process by recalling the comparison formula of the cube's spatial diagonal if the cube field was cut into an equilateral triangle. It was in line with [43], [44]. The study found that the subject found difficulties while solving the problems. Thus, he recalled the previous knowledge. This action is called a reversal. In this stage, the subject reached the indicators of spatial relation and thinking rotation correctly. The subject could make a sketch correctly, although it was difficult to understand. It was because he made it by using symbols. In this stage, the subject correctly used his spatial thinking concept, representative tool, and reasoning process. These elements appeared on the stage, and the subject utilized them correctly.

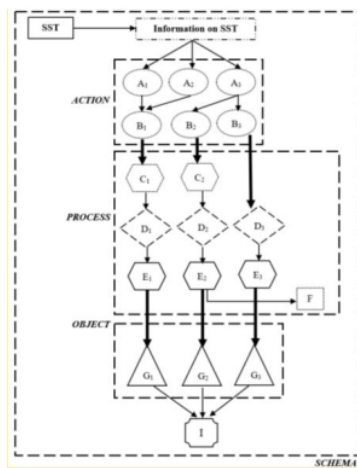











Figure 5. The spatial thinking process analysis of the subject

Table 2. The code remarks of Figure 5

Graphic codes	Remarks	Graphic codes	Remarks
SST	Spatial Skill Task	G <sub>1</sub>	Determining the distance of a field to a field
A <sub>1</sub>	Identifying the father's box	G <sub>2</sub>	Determining the distance of a point to a field
A <sub>2</sub>	Identifying Arfa's box	G <sub>3</sub>	Determining the distance of a point to a line
A <sub>3</sub>	Identifying little brother's box	I	The distance of the connecting segment of both geometrical fields with the lowest value
B <sub>1</sub>	Identifying the distance of red toward yellow plywood		Spatial Skill Task
B <sub>2</sub>	Identifying the distance of point H to ACG field.		The spatial concept
B <sub>3</sub>	Identifying the distance of point P to field AG		The representing tool
C <sub>1</sub>	Presupposing the father's box sides		Reasoning process
C <sub>2</sub>	Presupposing Arfa's box sides		Spatial perceptions
D <sub>1</sub>	The sketch of father's box		Spatial visualization
D <sub>2</sub>	The sketch of Arfa's box		Mental rotation
D <sub>3</sub>	The sketch of the little brother's box		Spatial relationship
E <sub>1</sub>	Connecting the line to determine the distance of a field to another field		Spatial orientation
E <sub>2</sub>	Connecting the line to determine the distance of a point to a field		Promoting mental mechanism
E <sub>3</sub>	Connecting the line to determine the distance of a point to a line		Using other mental structure
F	Recalling the comparison formula of the spatial diagonal length		

The mental structure stage showed the subject did mental encapsulation mechanism without de-encapsulation. He incorrectly determined the distance of a point to a line but he thought it was already correct. He did not explain the finishing process completely. It was in line with [45]. The study found that the obtained results had a doubt, and it made individuals elaborate and recall their previous knowledge. Thus, this individual conducted a de-encapsulation process. The subject did not do the de-encapsulation because he was an FD-typed student. The FD style usually uses previous experience to solve problems. Thus, he could solve problems without thinking longer. He used his previous experience to do it, although it was incorrect. Experience is an influential factor of an individual's cognitive development with FD type [46]. It was in line with [47]. An FD typed student perceived the represented question pattern in the geometrical figure without seeing the figure structures in detail. In this stage, the subject used the reasoning thinking process correctly and incorrectly. The subject could reach spatial skill indicators of spatial perception.

In the scheming stage, the subject did thematization by constructing the mental structure action, process, and object. The thematization result found that the subject could understand and determine the distance. It was the segment length connecting the two geometrical fields with the lowest value or short. Unfortunately, the result was incorrect. It was due to the mistakes he made while sketching and determining the line of the distance. The FD typed subject promoted three spatial thinking elements correctly. Unfortunately, he made a mistake while sketching the distance of a point to a line. The subject reached the indicator of spatial orientation indicator in his thematization stage. It proved that he could reach all spatial skill indicators, although the result was incorrect. He answered based on the given parts, but he could not explain the problems in detail. Previous study [48] found that an FD typed student learned based on the object-interaction type with his surroundings and the difficulty of separating the items from the context.

The findings showed that field-dependent students did not use the representative thinking element accurately, so the indicators of spatial perception could not be reached. It caused inaccuracy while solving the problems. The finding is in line with [49]. The research found that field-dependent typed students could not extract the important spatial information and could not use it. They also needed the contextual information than the complex configuration. This study also could not detect the attached figures completely [50]. The finding is also in line with [51]. The research showed that field-dependent students had lower performance in the spatial task. They also did not have complex skills in terms of mental rotation. The findings showed that subjects with field-dependent cognitive styles had partial type cognition to reconstruct the geometric concept. The partial thinking type has some indicators, such as misunderstanding in the representative cognition, lack of spatial thinking perception, and lack of de-encapsulation mental mechanism, meaning that the students

could not break the background knowledge to understand the problems. These indicators must be achieved in the spatial thinking process and developed to create accurate and complete spatial thinking skills.

#### 4. CONCLUSION

The researchers found the partial cognition of geometric concept reconstruction on the field-dependent students. This type has some indicators, such as the inaccuracy of spatial thinking skills. It dealt with the difficulties of the student to create a sketch. The student made it very brief and simple so that it could not be understood. The result was an inaccurate solution. Secondly, the lack of spatial perception made the learners inaccurately observed the figures from different positions. The student could not determine the lines and imagine the lines and the distances. Third, the student did not use a de-encapsulation mental mechanism. The student did not break and explain the background knowledge since the student believed it was correct. However, the result was the student did it incorrectly. The indicators must be achieved and develop to create complete and accurate spatial thinking skills. The students' thinking processes in constructing the geometric conceptual understanding were reviewed based on APOS. The field-dependent students tended to follow the existing experience, lack reconstructing skill, prioritizing the external knowledge, perceiving a pattern as the whole unit without breaking it down.

From the findings, the researcher recommends: i) The lecturers to promote the learning approach to improve the representative thinking element; ii) The students to be guided in explaining and breaking down the previous knowledge while solving problems; and iii) The future researchers to use APOS theory to reconstruct the conceptual understanding besides geometric material. This research was limited to the subjects with field-dependent cognitive type in constructing the geometric concept. Thus, it is recommended to investigate the other cognitive styles, such as field independent, neutral, reflective, and impulsive types. The tracing process should also use other theories, such as Piaget's or Mason's theory.

#### ACKNOWLEDGEMENTS

The completion of this research was due to the financial support of the Minister of Education, Culture, Research, and Technology of Republic Indonesia.

#### REFERENCES

- [1] H. S. Bintoro, Zaenuri, and Wardono, "Application of information technology and communication-based lesson study on mathematics problem-solving ability," *Journal of Physics: Conference Series*, vol. 1918, no. 4, p. 042105, 2021, doi: [10.1088/1742-6596/1918/4/042105](https://doi.org/10.1088/1742-6596/1918/4/042105).
- [2] S. Arici and F. Aslan-Tutak, "the Effect of Origami-Based Instruction on Spatial Visualization, Geometry Achievement, and Geometric Reasoning," *International Journal of Science and Mathematics Education*, vol. 13, no. 1, pp. 179–200, 2015, doi: [10.1007/s10763-013-9487-8](https://doi.org/10.1007/s10763-013-9487-8).
- [3] R. Horsman, "International perspectives on the teaching and learning of geometry in secondary schools," *Research in Mathematics Education*, vol. 21, no. 1, pp. 96–100, 2019, doi: [10.1080/14794802.2018.1531055](https://doi.org/10.1080/14794802.2018.1531055).
- [4] E. Zuliana, I. Oktavianti, Y. Ratnasari, and H. S. Bintoro, "Design and application of marionette tangram: An educational teaching media for mathematics and social science learning process in elementary schools," *Universal Journal of Educational Research*, vol. 8, no. 3, pp. 931–935, 2020, doi: [10.13189/ujer.2020.080326](https://doi.org/10.13189/ujer.2020.080326).
- [5] J. Dindyal, "Geometry in the early years: a commentary," *ZDM Mathematics Education*, vol. 47, no. 3, pp. 519–529, 2015, doi: [10.1007/s11858-015-0700-9](https://doi.org/10.1007/s11858-015-0700-9).
- [6] N. Sinclair and C. D. Bruce, "New opportunities in geometry education at the primary school," *ZDM*, vol. 47, no. 3, pp. 319–329, Jun. 2015, doi: [10.1007/s11858-015-0693-4](https://doi.org/10.1007/s11858-015-0693-4).
- [7] M. Cirillo and J. Hummer, "Competencies and behaviors observed when students solve geometry proof problems: an interview study with smartpen technology," *ZDM Mathematics Education*, vol. 53, pp. 861–875, 2021.
- [8] J. S. Thom and L. M. McGarvey, "The act and artifact of drawing(s): observing geometric thinking with, in, and through children's drawings," *ZDM Mathematics Education*, vol. 47, no. 3, pp. 465–481, 2015, doi: [10.1007/s11858-015-0697-0](https://doi.org/10.1007/s11858-015-0697-0).
- [9] E. Sevimli and A. Delice, "The influence of teacher candidates' spatial visualization ability on the use of multiple representations in problem solving of definite integrals: A qualitative analysis," *Research in Mathematics Education*, vol. 13, no. 1, pp. 93–94, 2011, doi: [10.1080/14794802.2011.550750](https://doi.org/10.1080/14794802.2011.550750).
- [10] J. Moss, Z. Hawes, S. Naqvi, and B. Caswell, "Adapting Japanese Lesson Study to enhance the teaching and learning of geometry and spatial reasoning in early years classrooms: a case study," *ZDM Mathematics Education*, vol. 47, no. 3, pp. 377–390, 2015, doi: [10.1007/s11858-015-0679-2](https://doi.org/10.1007/s11858-015-0679-2).
- [11] D. D. da Costa, "Mozambican student-teachers' perceptions of developing their understanding of teaching spatially dependent geometry," *African Journal of Research in Mathematics, Science and Technology Education*, vol. 18, no. 1, pp. 25–39, 2014, doi: [10.1080/10288457.2014.884354](https://doi.org/10.1080/10288457.2014.884354).
- [12] S. Khan, K. Francis, and B. Davis, "Accumulation of experience in a vast number of cases: enactivism as a fit framework for the study of spatial reasoning in mathematics education," *ZDM Mathematics Education*, vol. 47, no. 2, pp. 269–279, 2015, doi: [10.1007/s11858-014-0623-x](https://doi.org/10.1007/s11858-014-0623-x).
- [13] National Research Council, *Learning to Think Spatially*. Washington, DC: The National Academies Press, 2005. doi: [10.17226/11019](https://doi.org/10.17226/11019).







- [14] J. Mulligan, "Looking within and beyond the geometry curriculum: connecting spatial reasoning to mathematics learning," *ZDM Mathematics Education*, vol. 47, no. 3, pp. 511–517, 2015, doi: 10.1007/s11858-015-0696-1.
- [15] T. Logan and T. Lowrie, "Gender perspectives on spatial tasks in a national assessment: a secondary data analysis," *Research in Mathematics Education*, vol. 19, no. 2, pp. 199–216, 2017, doi: 10.1080/14794802.2017.1334577.
- [16] P. H. Maier, "Spatial Geometry and Spatial Ability - How to make solid Geometry solid?" in *Annual Conference of Didactics of Mathematics 1996*, 1998, pp. 63–75.
- [17] T. Septia, R. C. I. Prahmana, Pebrianto, and R. Wahyu, "Improving students spatial reasoning with course lab," *Journal on Mathematics Education*, vol. 9, no. 2, pp. 327–336, 2018, doi: 10.22342/jme.9.2.3462.327-336.
- [18] I. Arnon et al., *APOS Theory*. Springer New York, 2014, doi: 10.1007/978-1-4614-7966-6.
- [19] L. Mutambam and S. Bansilal, "An Exploratory Study on the Understanding of the Vector Subspace Concept," *African Journal of Research in Mathematics, Science and Technology Education*, vol. 23, no. 1, pp. 14–26, Jan. 2019, doi: 10.1080/18117295.2018.1564496.
- [20] V. Borji and R. Martínez-Planell, "On students' understanding of implicit differentiation based on APOS theory," *Educational Studies in Mathematics*, vol. 105, no. 2, pp. 163–179, Oct. 2020, doi: 10.1007/s10649-020-09991-y.
- [21] M. Trigueros, "The development of a linear algebra schema learning as result of the use of a cognitive theory and models," *ZDM - Mathematics Education*, vol. 51, no. 7, pp. 1055–1068, 2019, doi: 10.1007/s11858-019-01064-6.
- [22] E. K. Moru, "An APOS Analysis of University Students' Understanding of Derivatives: A Lesotho Case Study," *African Journal of Research in Mathematics, Science and Technology Education*, vol. 0, no. 0, pp. 1–14, 2020, doi: 10.1080/18117295.2020.1821500.
- [23] K. Moon, "New approaches for two-variable inequality graphs utilizing the Cartesian Connection and the APOS theory," *Educational Studies in Mathematics*, vol. 104, no. 3, pp. 351–367, Jul. 2020, doi: 10.1007/s10649-020-09956-1.
- [24] M. Altieri and E. Schirmer, "Learning the concept of eigenvalues and eigenvectors: a comparative analysis of achieved concept construction in linear algebra using APOS theory among students from different educational backgrounds," *ZDM - Mathematics Education*, vol. 51, no. 7, pp. 1125–1140, 2019, doi: 10.1007/s11858-019-01074-4.
- [25] F. M. Singer, C. Voica, and I. Pelczar, "Cognitive styles in posing geometry problems: implications for assessment of mathematical creativity," *ZDM - Mathematics Education*, vol. 49, no. 1, pp. 37–52, 2017, doi: 10.1007/s11858-016-0820-x.
- [26] A. L. Son, Darhim, and S. Fatimah, "Students' mathematical problem-solving ability based on teaching models intervention and cognitive style," *Journal on Mathematics Education*, vol. 11, no. 2, pp. 209–222, 2020, doi: 10.22342/jme.11.2.10744.209-222.
- [27] A. R. Masalimova et al., "The interrelation between cognitive styles and copying strategies among student youth," *Eurasia Journal of Mathematics, Science and Technology Education*, vol. 15, no. 4, pp. 1–7, 2019, doi: 10.29333/ejmste/103565.
- [28] X. Chen, S. Zhao, and W. Li, "Opinion Dynamics Model Based on Cognitive Styles: Field-Dependence and Field-Independence," *Complexity*, vol. 2019, pp. 1–12, Feb. 2019, doi: 10.1155/2019/2864124.
- [29] G. Tsitsipis, D. Stamovlasis, and G. Papageorgiou, "a Probabilistic Model for Students' Errors and Misconceptions on the Structure of Matter in Relation to Three Cognitive Variables," *International Journal of Science and Mathematics Education*, vol. 10, no. 4, pp. 777–802, 2012, doi: 10.1007/s10763-011-9288-x.
- [30] M. S. Motaahari and M. Norouzi, "The Difference between Field Independent and Field Dependent Cognitive Styles regarding Translation Quality," *Theory and Practice in Language Studies*, vol. 5, no. 11, p. 2373, Nov. 2015, doi: 10.17507/tpls.0511.23.
- [31] E. Khodadady and S. Zeynali, "Field-Dependence/Independence Cognitive Style and Performance on the IELTS Listening Comprehension," *International Journal of Linguistics*, vol. 4, no. 3, Sep. 2012, doi: 10.5296/ijl.v4i3.2389.
- [32] T. Muhammad, E. G. S. Daniel, and R. A. Abdurauuf, "Cognitive Styles Field Dependence/Independence and Scientific Achievement of Male and Female Students of Zamfara State College of Education Maru, Nigeria," *Journal of Education and Practice*, vol. 6, no. 10, pp. 58–64, 2015.
- [33] Kamid, M. Rusdi, O. Fitaloka, F. R. Basuki, and K. Anwar, "Mathematical communication skills based on cognitive styles and gender," *International Journal of Evaluation and Research in Education (IJERE)*, vol. 9, no. 4, pp. 847–856, 2020, doi: 10.11591/ijere.v9i4.20497.
- [34] M. Usman, R. Abdul, and S. A. Ansari, "An analysis of the ability in mathematical problem-solving based on SOLO taxonomy and cognitive style," *World Transactions on Engineering and Technology Education*, vol. 15, no. 1, pp. 68–73, 2017, [Online]. Available: <https://ssrn.com/abstract=2940939>.
- [35] S. Sumaji, C. Sa'dijah, and S. Sisworo, "Mathematical Communication Process of Junior High School Students in Solving Problems based on APOS Theory," *Journal for the Education of Gifted Young Scientists*, pp. 197–221, Mar. 2020, doi: 10.17478/jegys.652055.
- [36] Junarti, Y. L. Sukestiyamo, M. Mulyono, and N. Karomah, "The Process of Structure Sense of Group Prerequisite Material: A Case in Indonesian Context," *European Journal of Educational Research*, vol. 9, no. 3, pp. 1047–1061, Jul. 2020, doi: 10.12973/eu-jer.9.3.1047.
- [37] A. Shodiqin, Y. L. Sukestiyarno, Wardono, and Isnarto, "Probabilistic Thinking Profile of Mathematics Teacher Candidates in Problem Solving based on Self-Regulated Learning," *European Journal of Educational Research*, vol. 10, no. 3, pp. 1199–1213, 2021.
- [38] H. A. Witkin, *Group embedded figures test*. Redwood City, CA: Mind Garden, 2002.
- [39] M. B. Miles, A. M. Huberman, and J. Saldana, *Qualitative Data Analysis*. Los Angeles: SAGE Publications, 2020.
- [40] E. Hashimov, "Qualitative Data Analysis: A Methods Sourcebook and The Coding Manual for Qualitative Researchers," *Technical Communication Quarterly*, vol. 24, no. 1, pp. 109–112, Jan. 2015, doi: 10.1080/10572252.2015.975966.
- [41] Z. Ndlovu and D. Brijlall, "Pre-service Teachers' Mental Constructions of Concepts in Matrix Algebra," *African Journal of Research in Mathematics, Science and Technology Education*, vol. 19, no. 2, pp. 156–171, May 2015, doi: 10.1080/10288457.2015.1028717.
- [42] Y. Chen and F. Yang, "Problems Solving and Science Learning: An Eye," *International Journal of Science and Mathematics Education*, vol. 12, no. August 2013, pp. 579–603, 2014.
- [43] C. Kazunga and S. Bansilal, "An APOS analysis of solving systems of equations using the inverse matrix method," *Educational Studies in Mathematics*, vol. 103, no. 3, pp. 339–358, Mar. 2020, doi: 10.1007/s10649-020-09935-6.
- [44] H. S. Bintoro, Y. L. Sukestiyamo, Mulyono, and Walid, "The Spatial Thinking Process of the Field-Independent Students based on Action-Process-Object-Schema Theory," *European Journal of Educational Research*, vol. 10, no. 4, pp. 1807–1823, 2021, doi: 10.12973/eu-jer.10.4.1807.
- [45] A. Okaç, "Mental constructions in linear algebra," *ZDM - Mathematics Education*, vol. 51, no. 7, pp. 1043–1054, 2019, doi: 10.1007/s11858-019-01037-9.
- [46] N. Reid, "Field Dependency and Performance in Mathematics," *European Journal of Educational Research*, vol. 3, no. 1, pp. 43–57, 2014, doi: 10.12973/eu-jer.3.1.43.

*The spatial thinking process of the field-dependent students in reconstructing ... (Henry Suryo Bintoro)*





- [47] Y. E. Setiawan, Purwanto, I. N. Parta, and Sisworo, "Generalization strategy of linear patterns from field-dependent cognitive style," *Journal on Mathematics Education*, vol. 11, no. 1, pp. 77–94, 2020, doi: 10.22342/jme.11.1.9134.77-94.
- [48] E. Cataloglu and S. Ates, "The Effects of Cognitive Styles on Naïve Impetus Theory Application Degrees of Pre-Service Science Teachers," *International Journal of Science and Mathematics Education*, vol. 12, no. 4, pp. 699–719, Aug. 2014, doi: 10.1007/s10763-013-9430-z.
- [49] L. Tascón, M. Boccia, L. Piccardi, and J. M. Cimadevilla, "Differences in spatial memory recognition due to cognitive style," *Frontiers in Pharmacology*, vol. 8, pp. 1–7, 2017, doi: 10.3389/fphar.2017.00550.
- [50] M. Boccia, F. Vecchione, L. Piccardi, and C. Guariglia, "Effect of cognitive style on learning and retrieval of navigational environments," *Frontiers in Pharmacology*, vol. 8, no. JUL, pp. 1–10, 2017, doi: 10.3389/fphar.2017.00496.
- [51] A. Bocchi, M. Giancola, L. Piccardi, M. Palmiero, R. Nori, and S. D'Amico, "How would you describe a familiar route or put in order the landmarks along it? It depends on your cognitive style!," *Experimental Brain Research*, vol. 236, no. 12, pp. 3121–3129, Dec. 2018, doi: 10.1007/s00221-018-5367-3.

## BIOGRAPHIES OF AUTHORS







**Henry Suryo Bintoro**     is a graduate of the Mathematics Education Study Program at Sebelas Maret University, Surakarta (2007) and continues the Master's Program at the Postgraduate Program at Sebelas Maret University, Surakarta, majoring in Mathematics Education (2010). He is currently conducting a Doctoral study in Mathematics Education at the State University of Semarang in 2020. He is a permanent lecturer in the Mathematics Education Study Program at Muria Kudus University since 2011. His teaching experiences include teaching Basic Geometry, Spatial Geometry, Analytical Geometry, Transformational Geometry, and Euclid's Geometry. He can be contacted by email: [henrysuryo18@students.unnes.ac.id](mailto:henrysuryo18@students.unnes.ac.id); [henry.suryo@umk.ac.id](mailto:henry.suryo@umk.ac.id).







**Yohanes Leonardus Sukestiyarno**     is a civil servant lecturer at Semarang State University. Currently, he is not in further study. He joined the State University of Semarang as a civil servant lecturer on March 1, 1984. His last education was at the Strata 3 (S3) level and graduated on November 14, 1999. He is a civil servant Lecturer with the position of Professor and Head of the Doctoral Study Program Mathematics Education Semarang State University. He teaches the main subjects of Research Methods; Statistics; probability theory; Computer 1 & 2; Science philosophy; Learning mathematics in English. If you need some questions, please contact him via email: [sukestiyarno@mail.unnes.ac.id](mailto:sukestiyarno@mail.unnes.ac.id).



**Mulyono**     is a civil servant lecturer at Semarang State University. Currently, he is not in further study. He joined the State University of Semarang as a civil servant lecturer on February 1, 1997. His last education was at the Strata 3 (S3) level and graduated on January 13, 2011. He is a civil servant lecturer with the position of Lector and Head of the Department of the Faculty of Mathematics and Natural Sciences, State University of Semarang. He teaches the main courses of Calculus and Discrete Mathematics. If you need some questions, please contact him via email: [mulyono.mat@mail.unnes.ac.id](mailto:mulyono.mat@mail.unnes.ac.id).



**Walid**     is a Doctor in Mathematics. He earned his bachelor's degree at IKIP Semarang in the Department of Mathematics Education (graduated in 1998), while he obtained his master's degree at Gadjah Mada University (UGM, graduated in 2000). In 2016 he won his Doctorate at the same University when he took his Master's degree, namely at Gadjah Mada University. Currently, he is a lecturer at the Department of Mathematics and PPs, Semarang State University (UNNES). Since 2001, he has worked as a lecturer at the Mathematics Department of UNNES, since 2002 to 2009 he has served as a companion lecturer for university-level scientific works. He can be contacted by email: [walid.mat@mail.unnes.ac.id](mailto:walid.mat@mail.unnes.ac.id).

# The spatial thinking process of the field-dependent students in reconstructing the geometrical concept

## ORIGINALITY REPORT

16%

SIMILARITY INDEX

14%

INTERNET SOURCES

13%

PUBLICATIONS

8%

STUDENT PAPERS

## PRIMARY SOURCES

1	<a href="https://repository.unpkediri.ac.id">repository.unpkediri.ac.id</a> Internet Source	1%
2	Andi Saparuddin Nur, Kartono Kartono, Zaenuri Zaenuri, Rochmad Rochmad. "Solving mathematical word problems using dynamic assessment for scaffolding construction", International Journal of Evaluation and Research in Education (IJERE), 2022 Publication	1%
3	<a href="https://download.atlantis-press.com">download.atlantis-press.com</a> Internet Source	1%
4	Submitted to Academic Library Consortium Student Paper	1%
5	<a href="https://ijere.iaescore.com">ijere.iaescore.com</a> Internet Source	1%
6	<a href="https://journal.universitasmulia.ac.id">journal.universitasmulia.ac.id</a> Internet Source	1%
7	<a href="http://www.ejournal.radenintan.ac.id">www.ejournal.radenintan.ac.id</a> Internet Source	<1%

8	<a href="http://journal.yp3a.org">journal.yp3a.org</a> Internet Source	<1 %
9	<a href="http://www.tandfonline.com">www.tandfonline.com</a> Internet Source	<1 %
10	Giuseppe Città, Manuel Gentile, Mario Allegra, Marco Arrigo et al. "The effects of mental rotation on computational thinking", <i>Computers &amp; Education</i> , 2019 Publication	<1 %
11	<a href="http://researchprofiles.canberra.edu.au">researchprofiles.canberra.edu.au</a> Internet Source	<1 %
12	<a href="http://www.scilit.net">www.scilit.net</a> Internet Source	<1 %
13	Hamide Dogan, Edith Shear, Angel F. Garcia Contreras, Lion Hoffman. "Linear independence from a perspective of connections", <i>International Journal of Mathematical Education in Science and Technology</i> , 2021 Publication	<1 %
14	<a href="http://proc.iscap.info">proc.iscap.info</a> Internet Source	<1 %
15	Henry Suryo Bintoro, Y. L. Sukestiyarno, Mulyono, Walid. "Students mathematical thinking process with symbolic representation	<1 %



in reconstructing numerical literacy concepts",  
AIP Publishing, 2022

Publication

16

J.M. Aarts. "Plane Geometry", Plane and Solid  
Geometry, 2009

Publication

<1 %

17

[jurnalbeta.ac.id](http://jurnalbeta.ac.id)

Internet Source

<1 %

18

Submitted to Canterbury Christ Church  
University

Student Paper

<1 %

19

Submitted to National University of Singapore

Student Paper

<1 %

20

Eunice Kolutsoe Moru. "An APOS Analysis of  
University Students' Understanding of  
Derivatives: A Lesotho Case Study", African  
Journal of Research in Mathematics, Science  
and Technology Education, 2020

Publication

<1 %

21

[ftp.math.utah.edu](http://ftp.math.utah.edu)

Internet Source

<1 %

22

[hal.archives-ouvertes.fr](http://hal.archives-ouvertes.fr)

Internet Source

<1 %

23

[pjmhsonline.com](http://pjmhsonline.com)

Internet Source

<1 %

24

[www.amesa.org.za](http://www.amesa.org.za)

Internet Source

<1 %

25

[www.hindawi.com](http://www.hindawi.com)

Internet Source

<1 %

26

[www.slideshare.net](http://www.slideshare.net)

Internet Source

<1 %

27

Vahid Borji, Rafael Martínez-Planell, María Trigueros. "Student understanding of functions of two variables: A reproducibility study", *The Journal of Mathematical Behavior*, 2022

Publication

<1 %

28

[eprof.fmipa.unm.ac.id](http://eprof.fmipa.unm.ac.id)

Internet Source

<1 %

29

Raffaella Nori, Massimiliano Palmiero, Alessia Bocchi, Anna Maria Giannini, Laura Piccardi. "The specific role of spatial orientation skills in predicting driving behaviour", *Transportation Research Part F: Traffic Psychology and Behaviour*, 2020

Publication

<1 %

30

[media.neliti.com](http://media.neliti.com)

Internet Source

<1 %

31

Submitted to Aberystwyth University

Student Paper

<1 %

[acikbilim.yok.gov.tr](http://acikbilim.yok.gov.tr)

32

Internet Source

&lt;1 %

33

[nap.nationalacademies.org](http://nap.nationalacademies.org)

Internet Source

&lt;1 %

34

[repository.up.ac.za:8080](http://repository.up.ac.za:8080)

Internet Source

&lt;1 %

35

Asian Review of Accounting, Volume 23, Issue 2 (2015)

Publication

&lt;1 %

36

Duong Huu Tong, Bui Phuong Uyen, Ngo Van Anh Quoc. "The improvement of 10th students' mathematical communication skills through learning ellipse topics", Heliyon, 2021

Publication

&lt;1 %

37

Enditiyas Pratiwi, Toto Nusantara, Susiswo Susiswo, Makbul Muksar. "Routines' errors when solving mathematics problems cause cognitive conflict", International Journal of Evaluation and Research in Education (IJERE), 2022

Publication

&lt;1 %

38

Ahmad Fauzi, Muhammad Saefi, Widi Cahya Adi, Evi Kristiana, Nurlita Lestariani. "Instrument evaluation of conspiracy theory about COVID-19: Exploratory factor analysis and confirmatory factor analysis",

&lt;1 %

# International Journal of Evaluation and Research in Education (IJERE), 2022

Publication

39

Submitted to Great Zimbabwe University

Student Paper

<1 %

40

Submitted to University of Nottingham

Student Paper

<1 %

41

[uad.portalgaruda.org](http://uad.portalgaruda.org)

Internet Source

<1 %

42

Ni Putu Adelia Kesumaningsari, Jatie K. Pudjibudojo, Maya Hilda Lestari Louk.

"Teaching experience on online learning in higher education: Generational analysis",

Journal of Education and Learning (EduLearn), 2022

Publication

<1 %

43

[onlinelibrary.wiley.com](http://onlinelibrary.wiley.com)

Internet Source

<1 %

44

Brahm Norwich, George Koutsouris, Taro Fujita, Thomas Ralph, Anna Adlam, Fraser Milton. "Exploring knowledge bridging and translation in lesson study using an inter-professional team", International Journal for Lesson and Learning Studies, 2016

Publication

<1 %

45

Cathrine Kazunga, Sarah Bansilal. "Zimbabwean in-service mathematics

<1 %



teachers' understanding of matrix operations", The Journal of Mathematical Behavior, 2017

Publication

---

46

Yousef Abdelqader Abu Shindi, Aieman Ahmad Al-Omari. "Factorial validity of the organizational health inventory among Omani teachers: Invariance across gender", International Journal of Evaluation and Research in Education (IJERE), 2022

Publication

---

47

Submitted to Cardiff University

Student Paper

---

48

[jurnal.uns.ac.id](http://jurnal.uns.ac.id)

Internet Source

---

49

[link.springer.com](http://link.springer.com)

Internet Source

---

50

[www.jesoc.com](http://www.jesoc.com)

Internet Source

---

51

Ann Sophie Stuhlmann. "Interactionist perspective on negotiation processes of students' different understandings during small group work on linear algebra", The Journal of Mathematical Behavior, 2021

Publication

---

52

Submitted to Universitas Pakuan

Student Paper

---

<1 %

<1 %

<1 %

<1 %

<1 %

<1 %

<1 %

Exclude quotes      On

Exclude matches      < 10 words

Exclude bibliography      Off

# The spatial thinking process of the field-dependent students in reconstructing the geometrical concept

---

## GRADEMARK REPORT

---

FINAL GRADE

**/0**

GENERAL COMMENTS

**Instructor**

---

PAGE 1

---

PAGE 2

---

PAGE 3

---

PAGE 4

---

PAGE 5

---

PAGE 6

---

PAGE 7

---

PAGE 8

---

PAGE 9

---