

Microwave heating control system using genetic algorithm-based PID controller

by Dhidik Prastiyanto

Submission date: 10-Oct-2022 07:42AM (UTC+0700)

Submission ID: 1920948483

File name: g_control_system_using_genetic_algorithmbased_PID_controller.pdf (835.1K)

Word count: 4424

Character count: 22901

PAPER · OPEN ACCESS

Microwave heating control system using genetic algorithm-based PID controller

To cite this article: E Apriaskar *et al* 2022 *IOP Conf. Ser.: Earth Environ. Sci.* **969** 012060

View the [article online](#) for updates and enhancements.

You may also like

- [Simulation model of speed control DC motor using fractional order PID controller](#)
Tigo Wati, Subiyanto and Sutarno
- [Modified ant colony optimization based PID controller design for coupled tank system](#)
Sumika Chauhan, Bhawana Singh and Manmohan Singh
- [Experimental studies on active vibration control of a smart composite beam using a PID controller](#)
Miroslav M Jovanovi, Aleksandar M Simonovi, Nemanja D Zori et al.



The Electrochemical Society
Advancing solid state & electrochemical science & technology

242nd ECS Meeting

Oct 9 – 13, 2022 • Atlanta, GA, US

Early hotel & registration pricing ends September 12

Presenting more than 2,400 technical abstracts in 50 symposia

The meeting for industry & researchers in

BATTERIES
ENERGY TECHNOLOGY
SENSORS AND MORE!

 Register now!



 ECS Plenary Lecture featuring
M. Stanley Whittingham,
Binghamton University
Nobel Laureate –
2019 Nobel Prize in Chemistry

Microwave heating control system using genetic algorithm-based PID controller

E Apriaskar¹, D Prastiyanto¹, M A Malik¹, A E Ramadhan¹, R Destanto¹, H Abdullah@Idris² and M K Osman²

¹Department of Electrical Engineering, Faculty of Engineering, Universitas Negeri Semarang, Semarang 50229, Indonesia

²Faculty of Electrical Engineering, Universiti Teknologi MARA Cawangan Pulau Pinang, 13500 Permatang Pauh, Pulau Pinang, Malaysia

esa.apriaskar@mail.unnes.ac.id

Abstract. The superiorities of microwave heating technology have attracted many researchers for further development. Designing a satisfying temperature control system for the microwave system is one of them. To confirm that the controller can work with good system performance, the adjustment of controller parameters is important. Most previous research about microwave control systems did not focus on the tuning problem which is presented in this work. This paper provides the use of a genetic algorithm to adjust the best parameters for a PID controller. A microwave heating system with a single microwave power input and a single output temperature probe which is identified using the ARX model is examined. Evaluation of the proposed controller was conducted in the simulation environment using MATLAB. The result shows that the genetic algorithm can obtain the most optimized parameter for PID controller which can follow a certain heating pattern. The parameters for K_p , K_i , and K_d are 998.94, 79.42, and 79.78, respectively. It can minimize the value of integral absolute error for the given setpoint to 446.11.

1. Introduction

In the middle of industry 4.0 revolution, heating technology has also developed, not only for the design but also the process. Microwave heating system is one of high technologies in heating process that has benefited in many areas of industrial processes, such as food, wood, ceramic, plastics, etc. With the use of microwave heating system, it is possible to heat an object selectively or entirely and homogeneously in distribution. It is one of superiorities that microwave heating system can provide among the other heating technology [1].

Several works on microwave heating technology had been conducted by engineers. They covered starting from modelling microwave heating system [2–4], designing the control system for temperature produced by microwave generator [5-7], to performance evaluation of products processed by microwave heating system [8-10].

Research on microwave heating system model mainly aimed to obtain the most appropriate model applied to heat a certain product with predefined performances [11]. Designing the model of microwave cavity or waveguide and evaluation of the position of microwave generator are some focuses that researchers concerned for in terms of research on microwave heating system model [12,13]. Besides, there are also few researchers who took part in modelling the dynamics of microwave heating system.



Content from this work may be used under the terms of the [Creative Commons Attribution 3.0 licence](https://creativecommons.org/licenses/by/3.0/). Any further distribution of this work must maintain attribution to the author(s) and the title of the work, journal citation and DOI.

Published under licence by IOP Publishing Ltd

A research conducted by Yuan et al. [14] can be one of the corresponding works. It resulted a mathematical model that could connect the mathematical relation between a microwave power signal as an input of microwave heating system and the measured temperature as an output. On the other hand, works about microwave heating system control mainly deal with the effort to obtain system response with a certain set point value for the measured temperature [15]. It could be developing a new control method or modifying the existing controller to perform better responses. Furthermore, the improvement works in modelling and control method of microwave heating could contribute indirectly to improve the quality of products processed by microwave heating technology [16]. It is the reason why improvement in modelling and control of microwave heating system are still necessary.

This research has more concern in temperature control of microwave heating system. Several previous works have produced an interest to initiate this research. A work done by Yuan et al. [17] is one of them that explains methods to adjust the power coefficient of microwave generator using two different controllers. This work compared sliding mode controller (SMC) and proportional integral derivative (PID) to define the best control method among the two for tracking the required temperature profile. Another work about temperature control in microwave heating technology had also been conducted by Li et al. [18] which is utilized for 3D printing system. In that work, the microwave heating was aimed to strengthen the mechanical properties of a carbon fibre. The controller used in that work was a combination between prediction model and step proportional integral derivative control method. The controller tended to reduce the temperature deviation of continuous carbon fibre reinforced polymer (CCFRP) filament during the printing process. Hybrid control system for microwave heating process had also been developed by Yuan et al. [19] that were used for lignite drying. The controller had two PID modes and a zero mode that could dry a wet lignite safely and efficiently with 7% in moisture content. The three works mentioned had involved the use of PID controller to drive the microwave systems achieving the desired temperature. It convinced this research to use PID controller as the main control method.

Another research conducted by Tofighi and Attaluri [20] is such a relief to this work because it introduced the use of more efficient way to adjust the microwave power input rather than complex power adjustable microwave sources often used in microwave heating application. It used Arduino microcontroller with radio frequency driver amplifier, PNP BJT power transistor, and NPN transistor (2N3903) to produce pulse width modulation (PWM) signal for driving the microwave power value. It can make the implementation of PID controller for microwave heating system using PWM signal becomes more reliable.

However, being able to implement PID controller for microwave heating system is not enough. Determining the controller parameters of PID to optimize the system performance is not a trivial problem. The usage of artificial intelligence often succeeds in obtaining the most optimum parameter for a controller [21]. From research conducted by Feng [22], the use of genetic algorithm could tune and obtain the best PID controller parameter for controlling a certain plant. It shows that the use of GA can improve the accuracy performance of tracking control conducted by the plant. In this work, the control system for microwave heating process utilizes genetic algorithm to obtain the most optimum parameters for PID controller.

This paper is organized as follow. After several motivation and backgrounds that drive this work in section 1, section 2 explains the system and methods used in this work. It includes the microwave heating system model and the proposed method involving PID controller and genetic algorithm. In section 3, evaluations of the proposed controller through simulations are discussed. Then section 4 concludes the contribution of this work along with suggestions for future development.

2. Design and Method

2.1. Microwave Heating System Model

The design of microwave heating system evaluated in this paper as shown in Figure 1. It has an input in the form of microwave power input and an output in the form of measure temperature. Mathematical

model for that microwave heating system was developed by Yuan et al. [14] using black-box identification approach. That approach considers microwave heating system as a black box which has a time-series input signal and a time-series output signal. From both signals, an identification method produces the mathematical model in the form of ARX-based model. Considering continuous-time linear system with delay-time input, microwave heating system can be modelled with equation as shown in equation (1).

$$y(t) = a_1 y(t-1) + \dots + a_n y(t-n) = b_1 u(t-1) + \dots + b_m u(t-m) \quad (1)$$

where $y(t)$ is an output signal of the system, while $u(t)$ is the input. Equation (2) shows the Laplace transform of equation (1), where $A(s)$ and $B(s)$ are shown in equation (3) and (4).

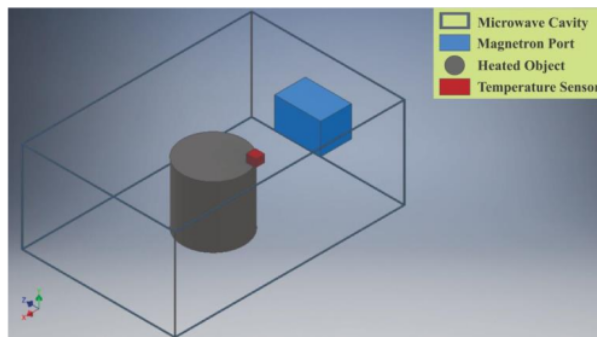

Figure 1. Microwave Heating System Design.

$$G(s) = \frac{B(s)}{A(s)} \quad (2)$$

$$A(s) = 1 + a_1 s + \dots + a_n s^n \quad (3)$$

$$B(s) = b_1 s + \dots + b_m s^m \quad (4)$$

$a_i (i = 1, \dots, n)$ and $b_j (j = 1, \dots, m)$ are model parameters that represent the dynamics of microwave heating system based on predefined input and output signals. From the continuous form of the system, we can obtain the mathematical equation for ARX-based model of the corresponding microwave heating system as written in equation (5), with $A(z)$ and $B(z)$ are described in equation (6) and (7).

$$A(z)y(t) = B(z)u(t) + e(t) \quad (5)$$

$$A(z) = 1 - 0.3149z^{-1} - 0.3164z^{-2} - 0.1912z^{-3} - 0.1773z^{-4} \quad (6)$$

$$B(z) = 3.97 \times 10^{-5} z^{-1} - 1.492 \times 10^{-5} z^{-2} + 5.33 \times 10^{-5} z^{-3} + 8.983 \times 10^{-5} z^{-4} \quad (7)$$

2.2. PID Controller

PID controller is one of well-known control methods that is widely used in many applications. Basically, PID controller utilizes output feedback to calculate error value of the system. Based on the calculated error value, PID controller adjusts the actuator output of the system. Since the actuator of the microwave heating system is the magnetron, so the PID controller produce an adjustment to the output of the magnetron, which is microwave power.

In continuous-time form, PID controller can be written as shown in equation (8). Equation (9) shows the transfer function of the controller after converting equation (8) with Laplace transform. Since the implementations of PID controller are often using microcontrollers, equation (9) needs to be transformed in discrete form. Equation (10) shows the discrete form of PID controller using the z-transform. Figure 2 depicts the simulation representation of discrete PID controller for microwave heating system.

$$u(t) = K_p e(t) + K_i \int_0^t e(\tau) d\tau + K_d \frac{d}{dt} e(t) \quad (8)$$

$$C(s) = K_p + \frac{K_i}{s} + K_d s \quad (9)$$

$$C(z) = K_p + \frac{K_i T_s}{z-1} + \frac{K_d(z-1)}{T_s z} \quad (10)$$

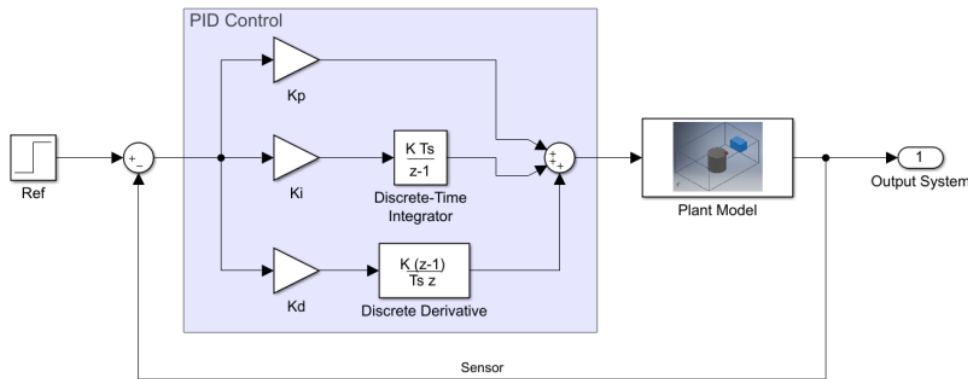

Figure 2. Discrete PID controller block diagram in MATLAB Simulink

There are three main components in PID controller, they are proportional, integral, and derivative. Each component has its own benefits and drawbacks [23]. Proportional component can fasten the response of the system but may produce high overshoot as the drawbacks. Integral part has the same impact with proportional in terms of overshoot and rise time, but it can eliminate the error steady state. Derivative part can improve the stability, especially when the response tends to have an oscillatory signal. However, derivative can give worse performance if the parameter tuning is not appropriate. It also happens to proportional and integral parameters. Therefore, a tuning method, such as Ziegler Nichols, as the most popular one, is usually utilized to obtain the appropriate value for controller parameter [24]. However, in this research, genetic algorithm is used to determine the parameter.

2.3. Proposed GA-based tuning method

Genetic algorithm (GA) is a heuristic optimization method which is inspired by natural evolution [25] and can be used to optimize controller parameters for PID [26]. Since GA adapts natural evolution, there are several terms like population, generation, crossing over and mutation. Each individual in a population has chromosomes which represent the solution candidates [27]. In this case, chromosomes contain controller parameters; they are K_p , K_i and K_d . Figure 3 depicts how GA works to tune the best parameter for PID controller.

It starts with preliminary setting of upper limit for K_p , K_i , and K_d constant to keep the searching range closes to the appropriate value. Because if one of the constants is too large, sometimes it can make the control signal becomes impossible to be implemented in the real electronic devices [28]. In this research, the searching ranges for K_p , K_i , and K_d are from 0 to 1000, 80, and 80, respectively. After

that, several main parameters for GA, like population size, generation number, mutation probability, and crossover probability, are determined. Table 1 declares the value of those parameters.

10
Table 1. GA parameters

Parameter	Value
Population size	20
Generation size	75
Mutation probability	0.3
Crossover probability	0.9

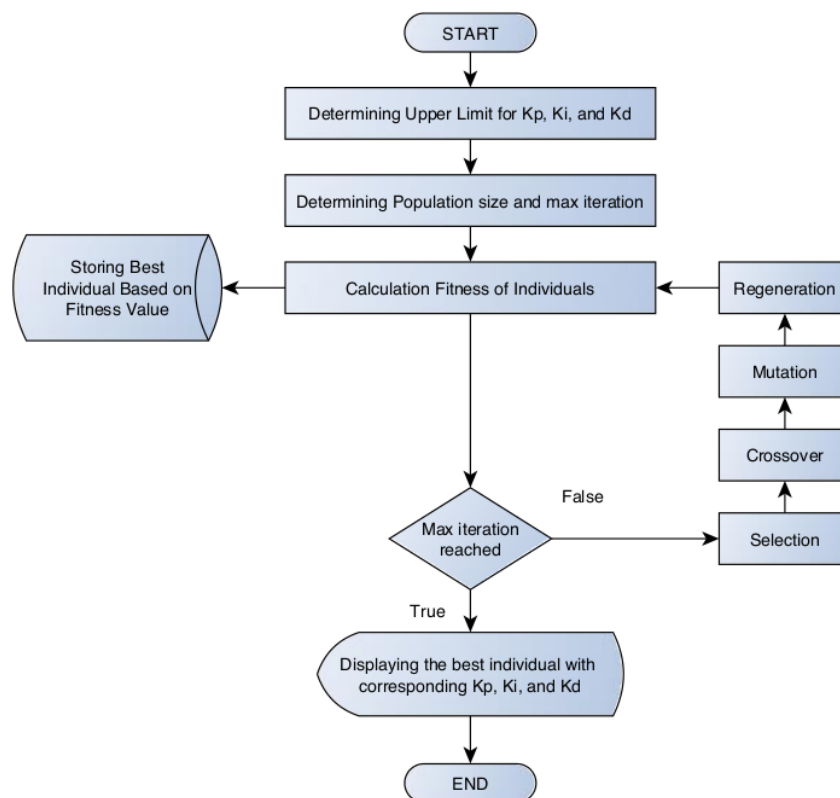

Figure 3. Flowchart of GA-based tuning for PID controller.

After parameter setting, the algorithm goes with calculating fitness value of each candidate in a population. It involves Integral Absolute Error (IAE) to get the fitness value with equation (11). The greater the fitness value indicates better solution to the problem. The algorithm continues with selection step to get two best candidates in a population. The two best candidates are then used in crossover and mutation steps, before conducting regeneration.

$$Fitness = 10^5 \int_0^{\infty} |e(t)| dt \quad (11)$$

As shown in Figure 4, for crossover, there are three possible actions involving the two best candidates who are then called as parent1 and parent2 to create two new individuals called child1 and child2. Those three actions are conducted based on the crossover probability. Two randomized integers between 0 and 1 are generated for parent1 and parent2, which are then called rand1 and rand2, respectively. Those two randomized integers are each compared with crossover probability. If both or one of them are smaller than crossover probability, then the algorithm permits the crossover, otherwise, child1 and child2 have the same chromosome with both parents.

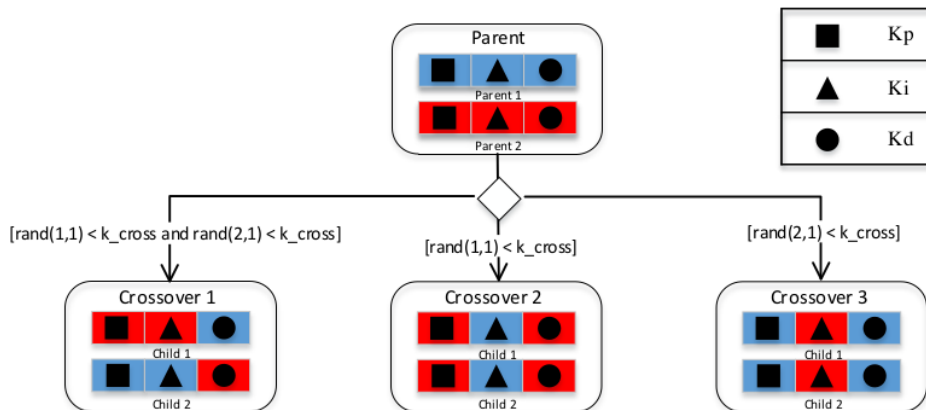

Figure 4. Chromosome's crossover of PID parameters

Mutation process uses child1 and child2 to create new candidates called mutant1 and mutant2. Same with the crossover, mutation conducts based on mutation probability. A randomized integer is generated for each chromosome of each child. If the generated integer is smaller than mutation probability, then the corresponding chromosome is regenerated, otherwise, the mutants have the same chromosome with child 1 and child2 correspondingly. It indicates that the resulted mutant has the same characteristic since there are not any chromosomes that are changed.

Mutants resulted from mutation process are then gathered with new individuals through regeneration step. Since the population size is 20, so there are 18 new generated individuals to create a new population for next generation together with the two mutants. The algorithm loops from fitness calculation of each candidate to regeneration step until the iteration reaches 75 as the generation size. After the looping stops, the best candidate of the last generation is considered as the best tuned controller parameter.

3. Results and Discussions

3.1. Population and generation size

In this work, the values of population size and generation size were obtained by conducting several trials. First, the generation size was set to a maximum value that was considered to cover the proper value. The maximum value was 100. There were three attempts to conduct the trials with generation size value in 100 and population size in 30. From the three trials as shown in Figure 5, it can be observed that after 75 generations, there are not any significant improvements in the fitness value. Hence, the value of generation size was set to 75.

After obtaining the value of generation size, the population size was evaluated using the same approach. Three values were compared each other using the obtained generation size; they were 15, 20, and 30. For each population size candidate, the genetic algorithm was examined three times. The best

trials for those three candidates are shown in Figure 6, with first sample is 15 in population size, while second and third samples are 20 and 30, respectively.

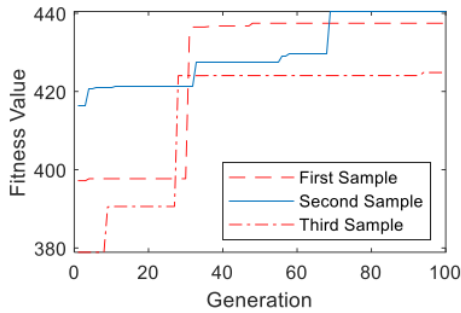

Figure 5. Three trials with generation size 100

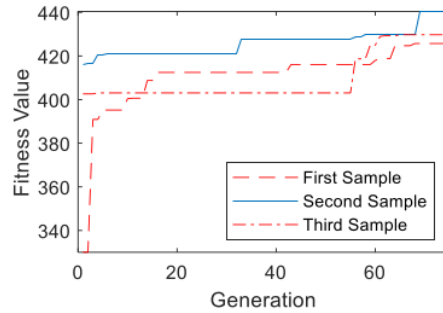

Figure 6. Trials with different population

From the graphs, there are several findings which lead to the decision of using 20 as the population size. The first finding is the number of improvements which happen through generations. Population 15 has the greatest number of improvements, followed by population 20 in the second place and population 30 has the least. However, when it comes to the final fitness value, population 20 shows better performance with final fitness value in around 440, while the others are smaller. According to [29], the population size should not be too large due to computation time limitation, but not too small due to poor performance. Since the second sample in Figure 6 does not have either the biggest size or the lowest size of population, but still produces a reasonable performance, it can be concluded that 20 is the most appropriate value for population size among the others.

3.2. Performance evaluation

Evaluations conducted in this research are aimed to examine the performance of the proposed method in the case of feedback control for microwave heating system. They included examining genetic algorithm as the optimization method and analysing the controlled system performance with the optimized parameters which was conducted using MATLAB Simulink as shown in Figure 2.

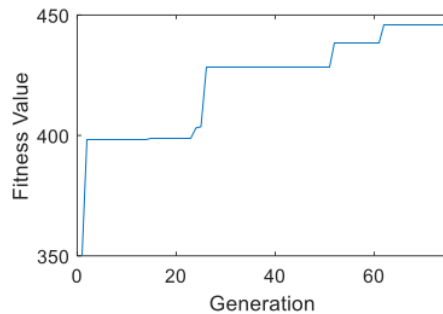

Figure 7. Best fitness value of each generation

The first evaluation which verified the success of genetic algorithm in obtaining the best solution of the optimisation problem can be shown from improvement of the fitness value throughout generation. The best fitness value of each generation which being larger clarify that the genetic algorithm tends to converge. The larger the final value of the fitness means that the speed of the convergence is faster [30]. Figure 7 depicts how the proposed GA could produce the best fitness value for each generation. It improved started from fitness value at around 350, with a significant improvement happened right before

30 generations and slight improvements until the end of the generation reaching almost 450 in fitness value, as also shown in Table 2 for the best result of IAE.

To justify that the obtained parameters after 20 running tests, as shown in Table 2, can work well for a certain case of microwave heating control system, the evaluation continued with reference tracking problem. The test was first initiated by determining heating pattern for a given period as the set point. The generated set point signal was set to start from 19 degrees and constantly increasing for approximately 250 seconds. After that, the heating was steady at around 45 before continuously went up to 75 degrees in Celsius and kept that value until the end of simulation time. Figure 8 illustrates the performance of the resulted parameters in the case of heating control system. It shows that the controlled system could properly track the heating pattern.

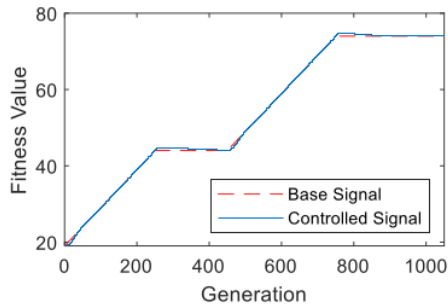

Figure 8. Output response of controlled system

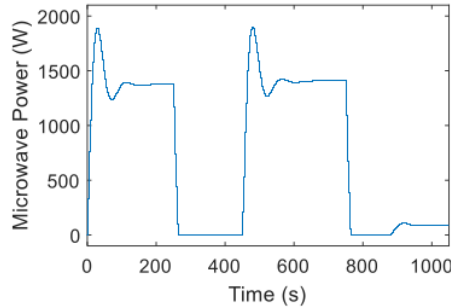

Figure 9. Generated PID control signal

Table 2. Tuning results for 20 running tests

Data Parameter	PID PARAMETERS			IAE
	Kp	Ki	Kd	
Best Result	998.94	79.42	79.78	446.11
Standard Deviation	24.33	1.74	5.01	9.43
Mean	965.94	77.64	74.83	431.20

As depicted in Figure 9, a control signal generated from the controller was varied with the maximum point not reaching 2000 W, which is the maximum power value of a common magnetron used in a microwave heating system. The limitation of the control signal, which was conducted by using anti-windup method aimed to the possibility of hardware implementation of the system can be a suggestion for future work. Another suggestion can also be inspired from the finding of standard deviation as listed on Table 2. It shows that the standard deviation for Ki parameter has already been good, but Kp and Kd still have considerable values. It can also be seen from the means of Kp and Kd that have sizeable gap from the best parameter based on IAE. Suggestions for this problem for further improvement can be the algorithm development, the determination of GA parameters, or adjusting the fitness function that can create a better repeatability.

4. Conclusion

Finally, this research contributes to present the tuning of PID controller parameter using genetic algorithm. Based on several tests conducted, the use of genetic algorithm worked well in the case of microwave heating control system. There were several trials to determine the population and generation size before the tuning process. Integral absolute error, as the evaluation criteria for each candidate,

worked well given the best fitness development data through the generation. The obtained parameters for the controller are 998.94, 79.42, and 79.78 for Kp, Ki and Kd, consecutively.

Considering the possibility of any future work regarding this research, limitation formula to avoid the control signal exceed the permissible value for the actuator can be one of them. The direction of future work can also be in the GA parameters selection or improvement of the fitness function used for the GA. Another optimization approach for the controller considering non-linearity of the system can also be the option for development.

Reference

- [1] Fulo H F, Vincent M A, Stiegman A E and Dudley G B 2020 *Asian J. Org. Chem.* **9** 961–966
- [2] Tamang S and Aravindan S 2019 susceptor *Appl. Therm. Eng.* **162** 114250
- [3] Hemis M, Watson D G, Gariépy Y, Lyew D and Raghavan V 2019 *M J. Microw. Power Electromagn. Energy* **53** 94–114
- [4] Yeong S P Law M C Vincent Lee C C and Chan Y S, 2017 *IOP Conf. Series: Materials Science and Engineering* **217** 12035
- [5] Ye, Jinghua Cun Z and H Zhu 2020 A Temperature-Control System for Continuous-Flow Microwave Heating Using a Magnetron as Microwave Source *IEEE Access* **8** 44391–44399
- [6] Cheng W, Liu T and Liang S 2020 *Int. Conf. on Advanced Mechatronic Systems (ICAMEchS)* 250–254
- [7] Fu T, Wang X and Yang G 2010 *Int.l Conf. on Computational and Information Sciences, ICCIS 2010* 1216–1219
- [8] Choi H, Koh T, Choi H and Hama Y 2019 Performance evaluation of precast concrete using microwave heating form *Materials (Basel)*. **12** 1113
- [9] Huang Y F, Chiueh P, Te, Kuan W H and Lo S L 2018 *Energy Procedia* **152** 910–915
- [10] Zhu H, Yuan H, Liu Y, Fan S and Ding Y 2020 *J. Mater. Civ. Eng.* **32** 04020248
- [11] Yan P, Stankiewicz A I, Eghbal S F and Nigar H 2021 *Chem. Eng. Sci.* **232** 116383
- [12] Feng T, Gao D P, Ding H B and Zhang Z C, 2016 *IEEE Int. Vacuum Electronics Conf. IVEC 2016* 1–2
- [13] Vencels J, Birjukovs M, Kataja J and Råback P 2019 *Case Stud. Therm. Eng.* **15** 100530
- [14] Yuan Y, Liang S, Zhong J, Xiong Q and Gao M 2015 *The 27th Chinese Control and Decision Conference (2015 CCDC)* 4116–4120
- [15] Li J, Xiong Q, Wang K, Shi X, Liang S and Gao M, 2016 *Dry. Technol.* **34** 215–226
- [16] Menéndez J A, Arenillas A, Fidalgo B, Fernandes Y, Zubizarreta L, Galvo E G and Bermudez J M 2010 *Fuel Processing Technology* **91** 1–8
- [17] Yuan Y, Liang S, Xiong Q, Zhong J and Wang Z 2016 *J. Therm. Sci. Technol.* **11** JTST0004–JTST0004
- [18] Li N, Link G and Jelonnek J 2020 *Compos. Sci. Technol.* **187** 107939
- [19] Yuan Y, Liang S, Gan S, Zhong J and Xiong Q 2017 *Dry. Technol.* **35** 1468–1480
- [20] Tofighi M R and Attaluri A 2020 *Trans. Instrum. Meas.* **70** 1–7
- [21] Triwiyatno A, Sumardi S and Apriaskar E 2017 *Iran. J. Fuzzy Syst.* **14** 1–13
- [22] Feng H *et al* 2018 *Mech. Syst. Signal Process* **105** 153–168
- [23] Xu X and Wang Q 2017 *Proc. - 2017 32nd. Youth Academic Annual Conf. of Chinese Association of Automation, YAC 2017* 812–817
- [24] Apriaskar E, Fahmizal F, Salim N A and Prastiyanto D 2019 *J. Tek. Elektro* **11** 44–49
- [25] McCall J 2005 *J. Comput. Appl. Math.* **184** 1
- [26] Zhang J, Zhuang J, Du H and Wang S 2009 *Inf. Sci. (Ny)*. **179** 7
- [27] Zhao M, Fu C, Ji L, Tang K and Zhou M 2011 *Expert Syst. Appl.* **38** 5
- [28] Jin M, Lee J Y, Chang P-H, Kim M-G and Kang S H 2017 *IFAC-PapersOnLine* **50** 4318–4323
- [29] Katoch S, Chauhan S S and Kumar V *Multimed. Tools Appl.* **80** 8091–8126
- [30] Tran H K Son H H Duc P Van Trang T T and Nguyen H-N 2020 Improved Genetic

Algorithm Tuning Controller Design for Autonomous Hovercraft *Processes* **8** 66

Acknowledgments

The authors would like to thank the Faculty of Engineering UNNES for the financial support of this research project. We also appreciate the Faculty of Engineering Universiti Teknologi MARA for the support and the collaboration for conducting this research work.

Microwave heating control system using genetic algorithm-based PID controller

ORIGINALITY REPORT

6%

SIMILARITY INDEX

4%

INTERNET SOURCES

6%

PUBLICATIONS

2%

STUDENT PAPERS

PRIMARY SOURCES

- 1 T A Ezangina, S A Gayvoronskiy, I V Khozhaev. "Parametric synthesis of a robust PID-controller for interval control system with aperiodic transient process", IOP Conference Series: Materials Science and Engineering, 2019
Publication 2%
- 2 centaur.reading.ac.uk
Internet Source 1%
- 3 Yupeng Yuan, Shan Liang, Jiaqi Zhong, Qingyu Xiong, Min Gao. "Black box system identification dedicated to a microwave heating process", The 27th Chinese Control and Decision Conference (2015 CCDC), 2015
Publication 1%
- 4 A. H. C. Patriota, E. M. Fernandes, J. J. Silva, J. S. da Rocha Neto. "Deformation closed-loop control of a flexible beam by means of a shape memory alloy", 2018 IEEE International <1%

Instrumentation and Measurement Technology Conference (I2MTC), 2018

Publication

-
- | | | |
|----|--|------|
| 5 | Mohamed Esmail Abed, Mo'men Aly, Hossam Hassan Ammar, Raafat Shalaby. "Steering Control for Autonomous Vehicles Using PID Control with Gradient Descent Tuning and Behavioral Cloning", 2020 2nd Novel Intelligent and Leading Emerging Sciences Conference (NILES), 2020
Publication | <1 % |
| 6 | Submitted to University of Reading
Student Paper | <1 % |
| 7 | www.coursehero.com
Internet Source | <1 % |
| 8 | eprints.utm.my
Internet Source | <1 % |
| 9 | www.mdpi.com
Internet Source | <1 % |
| 10 | www.scitepress.org
Internet Source | <1 % |
-

Exclude quotes On

Exclude matches < 10 words

Exclude bibliography On

Microwave heating control system using genetic algorithm-based PID controller

GRADEMARK REPORT

FINAL GRADE

/0

GENERAL COMMENTS

Instructor

PAGE 1

PAGE 2

PAGE 3

PAGE 4

PAGE 5

PAGE 6

PAGE 7

PAGE 8

PAGE 9

PAGE 10

PAGE 11
