



Volume 20, 25 November 2014

ISSN 1226-086X  
E-ISSN(s): 1876-794X

# Journal of Industrial and Engineering Chemistry

*J*  
*I*  
*E*  
*C*



The Korean Society of Industrial  
and Engineering Chemistry



# Journal of Industrial and Engineering Chemistry

Supports *open access*

[Articles & Issues](#) ▾

[About](#) ▾

[Publish](#) ▾

[Order journal](#) ↗

[Search in this journal](#)

## About the journal

[Aims and scope](#)

[Editorial board](#)

[Abstracting and indexing](#)

*Journal of Industrial and Engineering Chemistry* is published monthly in English by the [Korean Society of Industrial and Engineering Chemistry](#). *JIEC* brings together multidisciplinary interests in one journal and is to disseminate information on all aspects of research and development in **industrial and engineering chemistry**. Contributions in the form of research articles, short communications, notes and reviews are considered for publication. The [editors](#) welcome original contributions that have not been and are not to be published elsewhere. Instruction to authors and a manuscript [submissions](#) form are printed at the end of each issue. Bulk reprints of individual articles can be ordered. This publication is partially supported by [Korea Research Foundation](#) and the [Korean Federation of Science and Technology Societies](#).

# JOURNAL OF INDUSTRIAL AND ENGINEERING CHEMISTRY

## Editor-in-Chief

**Bok Ryul Yoo** (Korea Institute of Science and Technology)

## Editors

**Jin Woong Kim** (Hanyang University)

**Jonghwi Lee** (Chung-ang University)

**Jun Yeob Lee** (Dankook University)

**Sangho Lee** (Kookmin University)

**Tai Gyu Lee** (Yonsei University)

**Kyung-Won Park** (Soongsil University)

**Hyojong Yoo** (Hallym University)

## Editorial Board

**Wonyoung Choi** (Pohang University of Science and Technology)

**Yeong-Soon Gal** (Kyungil University)

**Seong-Soo Hong** (Pukyong National University)

**Young Taik Hong** (Korea Research Institute of Chemical Technology)

**Seok-Ho Hwang** (Dankook University)

**Kwang-Deog Jung** (Korea Institute of Science and Technology)

**Ki-Won Jun** (Korea Research Institute of Chemical Technology)

**Byung-Soo Kim** (Seoul National University)

**Dong-Pyo Kim** (POSTECH)

**Eunyoung Kim** (Yonsei University)

**Jae-Ho Kim** (Ajou University)

**Jin-Soo Kim** (Kyung Hee University)

**Ji Man Kim** (Sungkyungkwan University)

**Sang-Do Kim** (Korea Institute of Energy Research)

**Seung Wook Kim** (Korea University)

**Wha Jung Kim** (Konkuk University)

**Youngdae Kim** (Chonnam National University)

**Youngjo Kim** (Chungbuk National University)

**Youngkwan Lee** (Sungkyungkwan University)

**Sungyoung Mun** (Hanyang University)

**Kee Suk Nahm** (Chonbuk National University)

**H. Ryu** (Inje University)

**Sang Eun Shim** (Inha University)

**Yang-Kook Sun** (Hanyang University)

**Joo Young Yun** (Korea Research Institute of Standards and Science)

**Jongok Won** (Sejong University)

## International Advisory Board

**Masakazu Anpo** (Osaka Prefecture University, Japan)

**Jin Kun Cha** (Wayne State University, USA)

**Lih-Juann Chen** (National Tsing Hua University, Taiwan ROC)

**Yong-Bo Chong** (Research Institute for Applied Science, Japan)

**Myung S. Jhon** (Carnegie Mellon University, USA)

**Peter L. Lee** (Curtin University of Technology, Australia)

**Stanislav P. Malysenko** (Institute for High Temperature (IVTAN), Russia)

**Charles L. McCormick** (The University of Southern Mississippi, USA)

**Tsuyoshi Nakajima** (Kyoto University, Japan)

**Nicola Pinna** (University of Aveiro, Portugal)

**Jeffrey Pyun** (University of Arizona, USA)

**David A. Schiraldi** (Case Western Reserve University, USA)

**Duane H. Smith** (Department of Energy (Morgantown), USA)

**Gohsuke Sugihara** (Fukuoka University, Japan)

**Patrick Theato** (Johannes Gutenberg University of Mainz, Germany)

**Goran Ungar** (University of Sheffield, UK)

## Editorial Information

*Journal of Industrial and Engineering Chemistry* is published bimonthly in English by the Korean Society of Industrial and Engineering Chemistry. *J. Ind. Eng. Chem.* brings together multidisciplinary interests in one journal and is to disseminate information on all aspects of research and development in industrial and engineering chemistry. Contributions in the form of *research articles*, *short communications*, *notes*, and *reviews* are considered for publication. The editors welcome original contributions that have not been and are not to be published elsewhere. Instruction to authors are printed at the end of each issue. Page charges are paid to cover in part the cost of publication. Bulk reprints of individual articles can be ordered. This publication is partially supported by the National Research Foundation of Korea Grant funded by the Korean Government (MEST) and the Korean Federation of Science and Technology Societies.

## Journal of Industrial and Engineering Chemistry

The Korean Society of Industrial and Engineering Chemistry

905 Oryx Building, 755-5 Bangbae-dong, Seocho-gu, Seoul 137-828, Korea

Tel:82-2-594-4511~2 • Fax:82-2-594-4513

E-mail:ksiechem@chol.com, Homepage:www.ksiec.or.kr

Beginning with Issue 1 of Volume 4 (1998), information on the contents of *Journal of Industrial and Engineering Chemistry* is indexed in Science Citation Index®-Expanded, Research Alert®, Chemistry Citation Index®, and Reaction Citation Index®.



ScienceDirect

# Journal of Industrial and Engineering Chemistry

Supports open access

9.6

CiteScore

6.064

Impact Factor

 Search in this journal

[Submit your article ↗](#)

[Guide for authors ↗](#)

## Volume 20, Issue 6

Pages 3913-4508 (25 November 2014)

[Download full issue](#)

[← Previous vol/issue](#)

[Next vol/issue >](#)

Receive an update when the latest issues in this journal are published

[Sign in to set up alerts](#)

Full text access

[IFC \(Editorial Board\)](#)

[Page IFC](#)

[Download PDF](#)

[Reviews](#)

[FEEDBACK !\[\]\(a2bb1e57b467f1e41142026aa73db90f\_img.jpg\)](#)



Review article  Abstract only

### Recent application developments of water-soluble synthetic polymers

Kantappa Halake, Mallinath Birajdar, Byoung Soo Kim, Harim Bae, ... Jonghwi Lee

Pages 3913-3918

[Purchase PDF](#) Article preview 

Review article  Abstract only

### CFD simulation of fluidized bed reactors for polyolefin production – A review

M.J.H. Khan, M.A. Hussain, Z. Mansourpour, N. Mostoufi, ... E.C. Abdullah

Pages 3919-3946

[Purchase PDF](#) Article preview 

Review article  Abstract only

### Advanced metal oxide (supported) catalysts: Synthesis and applications

Dong Won Lee, Bok Ryul Yoo

Pages 3947-3959

[Purchase PDF](#) Article preview 

### Short Communications

Short communication  Abstract only

### Characteristics of nano-sized perovskite structured LaSrMn derived from hydrothermally synthesized amorphous LaSrMn oxide powder

Sora Kang, Byeong Sub Kwak, Byung-Hyun Choi, Sun-Min Park, ... Misook Kang

Pages 3960-3964

[Purchase PDF](#) Article preview 

Short communication  Abstract only

### Aerosol synthesis of macroporous silica adsorbents with high performance in paclitaxel purification from plant cell cultures

Hye Ran Jang, Jin-Hyun Kim, Kyeong Youl Jung

Pages 3965-3969

[Purchase PDF](#) Article preview 

## Research Articles

Research article  Abstract onlyA sonochemical method for synthesis of Fe<sub>3</sub>O<sub>4</sub> nanoparticles and thermal stable PVA-based magnetic nanocomposite

Davood Ghanbari, Masoud Salavati-Niasari, Majid Ghasemi-Kooch

Pages 3970-3974

[Purchase PDF](#) Article preview Research article  Abstract only

## Selective separation of salicylic acid from aqueous solutions using molecularly imprinted nano-polymer on wollastonite synthesized by oil-in-water microemulsion method

Minjia Meng, Yonghai Feng, Weisheng Guan, Yan Liu, ... Yongsheng Yan

Pages 3975-3983

[Purchase PDF](#) Article preview Research article  Abstract only

## The influence of nano-silica and zircon additions on the sintering and mechanical properties of in situ formed forsterite

M.M.S. Wahsh, A.G.M. Othman, S. Abd El-Aleem

Pages 3984-3988

[Purchase PDF](#) Article preview Research article  Abstract only

## Flame atomic absorption spectrometric determination of Cd, Pb, and Cu in food samples after pre-concentration using 4-(2-thiazolylazo) resorcinol-modified activated carbon

Mohamed Habila, Erkan Yilmaz, Zeid A. ALOthman, Mustafa Soylak

Pages 3989-3993

[Purchase PDF](#) Article preview Research article  Abstract only

## Hybrid magnetorheological elastomer: Influence of magnetic field and compression pressure on its electrical conductivity

Ioan Bica, Eugen M. Anitas, Madalin Bunoiu, Boris Vatzulik, Iulius Juganaru

Pages 3994-3999

[Purchase PDF](#) Article preview 

Research article  Abstract only

### Synthesis and application of lead telluride nanoparticles for degradation of organic pollution

Sousan Gholamrezaei, Masoud Salavati-Niasari, Davood Ghanbari

Pages 4000-4007

[Purchase PDF](#) [Article preview](#) 

Research article  Abstract only

### Photocatalytic oxidation of cyanide under visible light by Pt doped AgInS<sub>2</sub> nanoparticles

E.S. Aazam

Pages 4008-4013

[Purchase PDF](#) [Article preview](#) 

Research article  Abstract only

### Adsorption capacity of bone char for removing fluoride from water solution. Role of hydroxyapatite content, adsorption mechanism and competing anions

N.A. Medellin-Castillo, R. Leyva-Ramos, E. Padilla-Ortega, R. Ocampo Perez, ... M.S. Berber-Mendoza

Pages 4014-4021

[Purchase PDF](#) [Article preview](#) 

Research article  Abstract only

### Porosity changes during packed bed solid-state fermentation

A. Karimi, S.A. Shojaosadati, P. Hejazi, E. Vasheghani-Farahani, M. Hashemi

Pages 4022-4027

[Purchase PDF](#) [Article preview](#) 

Research article  Abstract only

### Sulfur-free exfoliated graphite with large exfoliated volume: Preparation, characterization and its adsorption performance

Qi Zhao, Xiuwen Cheng, Juan Wu, Xiujuan Yu

Pages 4028-4032

[Purchase PDF](#) [Article preview](#) 

Research article  Abstract only

### Photocatalytic oxidation of methylene blue dye under visible light by Ni doped Ag<sub>2</sub>S nanoparticles

E.S. Aazam

Pages 4033-4038

[Purchase PDF](#) Article preview 

Research article  Abstract only

### Synthesis and characterization of TiO<sub>2</sub> nanoparticles by using new shape controllers and its application in dye sensitized solar cells

Mahnaz Dadkhah, Masoud Salavati-Niasari, Noshin Mir

Pages 4039-4044

[Purchase PDF](#) Article preview 

Research article  Abstract only

### Thermodynamic adsorption data of CH<sub>4</sub>, C<sub>2</sub>H<sub>6</sub>, C<sub>2</sub>H<sub>4</sub> as the OCM process hydrocarbons on SAPO-34 molecular sieve

Mojtaba Masoudi-Nejad, Shohreh Fatemi

Pages 4045-4053

[Purchase PDF](#) Article preview 

Research article  Abstract only

### Synthesis, characterization and operation of a functionalized multi-walled CNT supported MnO<sub>x</sub> nanocatalyst for deep oxidative desulfurization of sour petroleum fractions

Neda Mohammadi Meman, Mahnaz Pourkhalil, Alimorad Rashidi, Bahman ZareNezhad

Pages 4054-4058

[Purchase PDF](#) Article preview 

Research article  Abstract only

### Determination of gold and palladium in environmental samples by FAAS after dispersive liquid-liquid microextraction pretreatment

Coşkun Özdemir, Şerife Saçmacı, Şenol Kartal, Mustafa Saçmacı

Pages 4059-4065

[Purchase PDF](#) Article preview 

Research article  Abstract only

### Controllable synthesis of Bi<sub>2</sub>S<sub>3</sub> via a simple hydrothermal approach starting from an inorganic precursor

Masoud Salavati-Niasari, Zeynab Behfard, Mahnaz Maddahfar

Pages 4066-4075

[Purchase PDF](#) Article preview 

Research article  Abstract only

### A rapid and high efficient microwave promoted multicomponent domino reaction for the synthesis of spirooxindole derivatives

Ramin Ghahremanzadeh, Zahra Rashid, Amir-Hassan Zarnani, Hossein Naeimi

Pages 4076-4084

[Purchase PDF](#) [Article preview](#) 

Research article  Abstract only

### Synthesis, characterization of Fe<sub>3</sub>O<sub>4</sub>@glycine doped polypyrrole magnetic nanocomposites and their potential performance to remove toxic Cr(VI)

N. Ballav, H.J. Choi, S.B. Mishra, A. Maity

Pages 4085-4093

[Purchase PDF](#) [Article preview](#) 

Research article  Abstract only

### Preparation and characterization of polymer/layered silicate pharmaceutical nanobiomaterials using high clay load exfoliation processes

Jaqueline Correia Villaça, Luiz Cláudio R. Pereira da Silva, Luisa Helena Falcão Barbosa, Carlos Rangel Rodrigues, ... e Lucio Mendes Cabral

Pages 4094-4101

[Purchase PDF](#) [Article preview](#) 

Research article  Abstract only

### One-step fabrication of Ce-N-codoped TiO<sub>2</sub> nano-particle and its enhanced visible light photocatalytic performance and mechanism

ZhaoHong Meng, LuHe Wan, Lijuan Zhang, ShuYing Zang

Pages 4102-4107

[Purchase PDF](#) [Article preview](#) 

Research article  Abstract only

### The effects of graphene on the properties of acrylic pressure-sensitive adhesive

Gi Ho Park, Ki Tae Kim, Young Tae Ahn, Hyung-il Lee, Han Mo Jeong

Pages 4108-4111

[Purchase PDF](#) [Article preview](#) 

Research article  Abstract only

### High surface area-activated carbon from *Glycyrrhiza glabra* residue by ZnCl<sub>2</sub> activation for removal of Pb(II) and Ni(II) from water samples

Sayed Zia Mohammadi, Hooshang Hamidian, Zahra Moeinadini

Pages 4112-4118

[Purchase PDF](#) Article preview 

Research article  Abstract only

### Sonochemical synthesis of $\text{CoFe}_2\text{O}_4$ nanoparticles and their application in magnetic polystyrene nanocomposites

Jilla Saffari, Davood Ghanbari, Noshin Mir, Khatereh Khandan-Barani

Pages 4119-4123

[Purchase PDF](#) Article preview 

Research article  Abstract only

### Electrochemical and anticorrosion behavior of functionalized graphite nanoplatelets epoxy coating

Somayeh Mohammadi, Faramarz Afshar Taromi, Homeira Shariatpanahi, Jaber Neshati, Mahmoud Hemmati

Pages 4124-4139

[Purchase PDF](#) Article preview 

Research article  Abstract only

### Vapor-phase selective hydrogenation of maleic anhydride to succinic anhydride over $\text{Ni}/\text{TiO}_2$ catalysts

Weitao Huo, Chunlei Zhang, Hongjing Yuan, Mingjun Jia, ... Wenxiang Zhang

Pages 4140-4145

[Purchase PDF](#) Article preview 

Research article  Abstract only

### Enhanced activity of MCM-48 based tin catalyst for synthesis of 3-methylbut-3-en-1-ol by adjusting the mesochannel environment

Zhaoyang Fei, Shenglan Ai, Zhe Zhou, Xian Chen, ... Xu Qiao

Pages 4146-4151

[Purchase PDF](#) Article preview 

Research article  Abstract only

### Synergistic effect of various neutral donors in D2EHPA for selective neodymium separation from lanthanide series via HFSLM

Thanaporn Wannachod, Natchanun Leepipatpiboon, Ura Pancharoen, Kasidit Nootong

Pages 4152-4162

[Purchase PDF](#) Article preview 

Research article  Abstract only

## Phase equilibria for the 2-ethoxyethyl acetate and 2-(2-ethoxyethoxy)ethyl acetate in supercritical CO<sub>2</sub> at various temperatures and pressures up to 20 MPa

Chang-Ryung Kim, Soon-Do Yoon, Hun-Soo Byun

Pages 4163-4168

[Purchase PDF](#) Article preview 

Research article  Abstract only

## Plant mediated green biosynthesis of silver nanoparticles using *Vitex negundo* L. extract

Mohsen Zargar, Kamyar Shamel, Gholam Reza Najafi, Farah Farahani

Pages 4169-4175

[Purchase PDF](#) Article preview 

Research article  Abstract only

## Preparation of promoted nickel catalysts supported on mesoporous nanocrystalline gamma alumina for carbon dioxide methanation reaction

Soudabeh Rahmani, Mehran Rezaei, Fereshteh Meshkani

Pages 4176-4182

[Purchase PDF](#) Article preview 

Research article  Abstract only

## Effective modification of Pd surfaces with TiO<sub>2</sub> promoters using selective chemical vapor deposition and the effect on catalytic performance improvement

Jo-Eun Um, Won Jung Yoon, Hyung-Wook Choi, Woo-Jae Kim

Pages 4183-4187

[Purchase PDF](#) Article preview 

Research article  Abstract only

## Synthesis, characterization and application of CdSe quantum dots

Karan Surana, Pramod K Singh, Hee-Woo Rhee, B. Bhattacharya

Pages 4188-4193

[Purchase PDF](#) Article preview 

Research article  Abstract only

## Synthesis, surface, thermodynamic properties and Biological activity of dimethylaminopropylamine surfactants

Samy M. Shaban, Ismail Aiad, Mohamed M. El-Sukkary, E.A. Soliman, Moshira Y. El-Awady

Pages 4194-4201

[Purchase PDF](#) Article preview 

Research article  Abstract only

### Synthesis and characterization of carbon/AlOOH composite for adsorption of chromium(VI) from synthetic wastewater

Rajeev Kumar, Muhammad Ehsan, M.A. Barakat

Pages 4202-4206

[Purchase PDF](#) Article preview 

Research article  Abstract only

### Mothproofing of wool fabric utilizing ZnO nanoparticles optimized by statistical models

Ali Nazari, Majid Montazer, Mehdi Dehghani-Zahedani

Pages 4207-4214

[Purchase PDF](#) Article preview 

Research article  Abstract only

### Sucrose-mediated sol-gel synthesis of nanosized pure and S-doped zirconia and its catalytic activity for the synthesis of acetyl salicylic acid

Ali Majedi, Fatemeh Davar, Alireza Abbasi

Pages 4215-4223

[Purchase PDF](#) Article preview 

Research article  Abstract only

### Catalytic-oxidation of Janus green in the presence of AgNPs: Application to the determination of iodate

S.S. Mortazavi, A. Farmany

Pages 4224-4226

[Purchase PDF](#) Article preview 

Research article  Abstract only

### New method in synthesis of nano uranyl(VI) Schiff base complexes: Characterization and electrochemical studies

Zahra Asadi, Mozaffar Asadi, Fahimeh Dehghani Firuzabadi, Mohammad Ranjkesh Shorkaei

Pages 4227-4232

[Purchase PDF](#) Article preview 

Research article  Abstract only

### Application of kinetic, isotherm and thermodynamic models for the adsorption of Co(II) ions on polyaniline/polypyrrole copolymer nanofibers from aqueous solution

Hamedreza Javadian

Pages 4233-4241



[Purchase PDF](#) Article preview 

Research article  Abstract only

### Reactive distillation in the intensification of oleic acid esterification with methanol – A simulation case-study

Mauro Banchero, Ratna Dewi Kusumaningtyas, Giuseppe Gozzelino

Pages 4242-4249

[Purchase PDF](#) Article preview 

Research article  Abstract only

### Powder metallurgy of Mg–1%Al–1%Sn alloy reinforced with low content of graphene nanoplatelets (GNPs)

Muhammad Rashad, Fusheng Pan, Muhammad Asif, Aitao Tang

Pages 4250-4255

[Purchase PDF](#) Article preview 

Research article  Abstract only

### Utilization of waste cation exchange resin to prepare carbon/iron composites for the adsorption of contaminants in water

Qianqian Shi, Aimin Li, Qing Zhou, Chendong Shuang, ... Yan Ma

Pages 4256-4260

[Purchase PDF](#) Article preview 

Research article  Abstract only

### Evaluation of thermodynamic and kinetic parameters for conducting nanocomposite polypyrrole zirconium titanium phosphate

Asif Ali Khan, Leena Paquiza

Pages 4261-4266

[Purchase PDF](#) Article preview 

Research article  Abstract only

### Synthesis, surface active and thermal properties of novel imidazolium cationic monomeric surfactants

Pankaj Patial, Arifa Shaheen, Ishtiaque Ahmad

Pages 4267-4275

[Purchase PDF](#) Article preview 

Research article  Abstract only

### Plant derived cationic dye as an effective corrosion inhibitor for 7075 aluminum alloy in 3.5% NaCl solution

Ambrish Singh, Yuanhua Lin, Wanying Liu, Shijie Yu, ... Deng Kuanhai

Pages 4276-4285

[Purchase PDF](#) Article preview 

Research article  Abstract only

### Fabrication of mesoporous carbons coated monolith via evaporative induced self-assembly approach: Effect of solvent and acid concentration on pore architecture

C.K. How, Moonis Ali Khan, Soraya Hosseini, T.G. Chuah, Thomas S.Y. Choong

Pages 4286-4292

[Purchase PDF](#) Article preview 

Research article  Abstract only

### Purification of papain from unclarified papaya juice using reversed phase expanded bed adsorption chromatography (RP-EBAC)

Yuhai He, Syed Mohd Saufi bin Tuan Chik, Fui Chin Chong

Pages 4293-4297

[Purchase PDF](#) Article preview 

Research article  Abstract only

### Preparation of Co–Mo supported multi-wall carbon nanotube for hydrocracking of extra heavy oil

Mohsen Rahimi Rad, Alimorad Rashidi, Leila Vafajoo, Maryam Rashtchi

Pages 4298-4303

[Purchase PDF](#) Article preview 

Research article  Abstract only

### Cadmium biosorption by a glyphosate-degrading bacterium, a novel biosorbent isolated from pesticide-contaminated agricultural soils

Elnaz Khadivinia, Hakimeh Sharafi, Faranak Hadi, Hossein Shahbani Zahiri, ... Kambiz Akbari Noghabi

Pages 4304-4310

[Purchase PDF](#) Article preview 

Research article  Abstract only

### Corrosion inhibition and adsorption behavior of new Schiff base surfactant on steel in acidic environment: Experimental and theoretical studies

S.A. Soliman, M.S. Metwally, S.R. Selim, M.A. Bedair, Mohamed A. Abbas

Pages 4311-4320

[Purchase PDF](#) Article preview 

Research article  Abstract only

### Synthesis and characterization of $\text{In}_2\text{S}_3$ nanostructures via ultrasonic method in the presence of thioglycolic acid

Hamideh Asadollahzadeh, Mehdi Ranjbar, Mohammad Ali Taher

Pages 4321-4326

[Purchase PDF](#) Article preview 

Research article  Abstract only

### Eco-friendly one-pot synthesis of gold decorated reduced graphene oxide using beer as a reducing agent

Mahmoud Amouzadeh Tabrizi, Azam Tavakkoli, Vivek Dhand, Kyong Yop Rhee, Soo-Jin Park

Pages 4327-4331

[Purchase PDF](#) Article preview 

Research article  Abstract only

### Artificial neural network – Imperialist competitive algorithm based optimization for removal of sunset yellow using $\text{Zn}(\text{OH})_2$ nanoparticles-activated carbon

M. Ghaedi, A.M. Ghaedi, E. Negintaji, A. Ansari, F. Mohammadi

Pages 4332-4343

[Purchase PDF](#) Article preview 

Research article  Abstract only

### Adsorption performance of suitable nanostructured novel composite adsorbent of poly(*N*-methylaniline) for removal of heavy metal from aqueous solutions

Hamedreza Javadian

Pages 4344-4352

[Purchase PDF](#) Article preview 

Research article  Abstract only

### Sorption studies of manganese and cobalt from aqueous phase onto alginate beads and nano-graphite encapsulated alginate beads

Moonis Ali Khan, Woosik Jung, Oh-Hun Kwon, Young Mee Jung, ... Byong-Hun Jeon

Pages 4353-4362

[Purchase PDF](#) Article preview 

Research article  Abstract only

### Electrochemical and quantum chemical investigation of inhibitory of 1,4- $\text{Ph}(\text{OX})_2(\text{Ts})_2$ on corrosion of 1005 aluminum alloy in acidic medium

Ali Ehsani, Mahmoud Nasrollahzadeh, Mohammad Ghasem Mahjani, Reza Moshrefi, Hossein Mostanzadeh

Pages 4363-4370

[Purchase PDF](#) Article preview 

Research article  Abstract only

### Sequential optimization strategy for hyaluronic acid extraction from eggshell and its partial characterization

Mehdi Khanmohammadi, Ali Baradar Khoshfetrat, Shahla Eskandarnezhad, Najimeh Feyze Sani, Sirius Ebrahimi

Pages 4371-4376

[Purchase PDF](#) Article preview 

Research article  Abstract only

### Novel Ag/YVO<sub>4</sub> nanoparticles prepared by a hydrothermal method for photocatalytic degradation of methylene-blue dye

R.M. Mohamed, E.S. Aazam

Pages 4377-4381

[Purchase PDF](#) Article preview 

Research article  Abstract only

### Homogeneous preparation of polyamidoamine grafted silica gels and their adsorption properties as Au<sup>3+</sup> adsorbents

Rongjun Qu, Xilu Ma, Minghua Wang, Changmei Sun, ... Ping Yin

Pages 4382-4392

[Purchase PDF](#) Article preview 

Research article  Abstract only

### Equilibrium, kinetics and thermodynamic studies for the removal of organophosphorus pesticide using Amberlyst-15 resin: Quantitative analysis by liquid chromatography–mass spectrometry

Mu. Naushad, Z.A. ALOthman, M.R. Khan, N.J. ALQahtani, I.H. ALSohaimi

Pages 4393-4400

[Purchase PDF](#) Article preview 

Research article  Abstract only

### Adsorption studies of methylene blue onto ZnCl<sub>2</sub>-activated carbon produced from buriti shells (*Mauritia flexuosa* L.)

Osvaldo Pezoti, André L. Cazetta, Isis P.A.F. Souza, Karen C. Bedin, ... Vitor C. Almeida

Pages 4401-4407

[Purchase PDF](#) Article preview 

Research article  Abstract only

### Synthesis and characterization of hybrid matrix with encapsulated organic sensing dyes for pH sensing application

Shumaila Islam, Rosly Rahman, Zulkafli Othaman, Saira Riaz, Shahzad Naseem

Pages 4408-4414

[Purchase PDF](#) Article preview 

Research article  Abstract only

### Facile preparation and characterization of poly(vinyl alcohol)/chitosan/graphene oxide biocomposite nanofibers

Yanan Liu, Mira Park, Hye Kyoung Shin, Bishweshwar Pant, ... Hak-Yong Kim

Pages 4415-4420

[Purchase PDF](#) Article preview 

Research article  Abstract only

### Investigation of different precipitating agents effects on performance of $\gamma$ -Al<sub>2</sub>O<sub>3</sub> nanocatalysts for methanol dehydration to dimethyl ether

Seyyed Yaghoob Hosseini, Mohammad Reza Khosravi Nikou

Pages 4421-4428

[Purchase PDF](#) Article preview 

Research article  Abstract only

### Heavy metal ions retention by bi-functionalized lignin: Synthesis, applications, and adsorption mechanisms

Yuanyuan Ge, Zhili Li, Yan Kong, Quanpeng Song, Kunqi Wang

Pages 4429-4436

[Purchase PDF](#) Article preview 

Research article  Abstract only

### Transesterification of waste cooking palm oil by MnZr with supported alumina as a potential heterogeneous catalyst

H. Amani, Z. Ahmad, M. Asif, B.H. Hameed

Pages 4437-4442

[Purchase PDF](#) Article preview 

Research article  Abstract only

### Effect of KOH on the continuous synthesis of cobalt oxide and manganese oxide nanoparticles in supercritical water

Agung Nugroho, Jaehoon Kim

Pages 4443-4446

[Purchase PDF](#) Article preview 

Research article  Abstract only

### Electrochemical properties of non-aqueous electrolytes containing spiro-type ammonium salts

Mingyeong Kim, Seok Kim

Pages 4447-4451

[Purchase PDF](#) Article preview 

Research article  Abstract only

### Anionic trash control in high-yield pulp (HYP) containing furnish by using a poly-DADMAC based commercial formulation

Yating Wang, Jianping Ni, Cui Chen, Jinyong Peng, Hongbin Liu

Pages 4452-4456

[Purchase PDF](#) Article preview 

Research article  Abstract only

### Separation and recovery of vanadium from leached solution of spent residuehydrodesulfurization (RHDS) catalyst using solvent extraction

Hong-In Kim, Ki-Woong Lee, Debaraj Mishra, Kang-Myong Yi, ... Hea-Kyung Park

Pages 4457-4462

[Purchase PDF](#) Article preview 

Research article  Abstract only

### Characterization, surface properties and biological activity of some synthesized anionic surfactants

Nabel A. Negm, Salah M. Tawfik

Pages 4463-4472

[Purchase PDF](#) Article preview 

Research article  Abstract only

### One step green synthesis of hexagonal silver nanoparticles and their biological activity

Samy M. Shaban, Ismail Aiad, Mohamed M. El-Sukkary, E.A. Soliman, Moshira Y. El-Awady

Pages 4473-4481

[Purchase PDF](#) Article preview 

Research article  Abstract only

## Preparation, characterization and antimicrobial activity of biopolymer based nanocomposite ion exchanger pectin zirconium(IV) selenotungstophosphate: Application for removal of toxic metals

Gaurav Sharma, Deepak Pathania, Mu. Naushad  
Pages 4482-4490

[Purchase PDF](#) Article preview [▼](#)

Research article  Abstract only

## Dynamic removal of *n*-hexane from water using nanocomposite membranes: Serial coating of para-aminobenzoate alumoxane, boehmite-epoxide and chitosan on Kevlar fabrics

Hanieh Karimnezhad, Ehsan Salehi, Laleh Rajabi, Sara Azimi, ... Meisam Ansari  
Pages 4491-4498

[Purchase PDF](#) Article preview [▼](#)

Research article  Abstract only

## Effluent organic matter removal from reverse osmosis feed by granular activated carbon and purolite A502PS fluidized beds

Sukanyah Shanmuganathan, Tien Vinh Nguyen, W.G. Shim, Jaya Kandasamy, ... Saravanamuthu Vigneswaran  
Pages 4499-4508

[Purchase PDF](#) Article preview [▼](#)

---

[< Previous vol/issue](#)

[Next vol/issue >](#)

ISSN: 1226-086X

Copyright © 2021 The Korean Society of Industrial and Engineering Chemistry. All rights reserved



Copyright © 2021 Elsevier B.V. or its licensors or contributors.  
ScienceDirect® is a registered trademark of Elsevier B.V.

FEEDBACK [🗨️](#)





# Reactive distillation in the intensification of oleic acid esterification with methanol – A simulation case-study



Mauro Banchemo <sup>a,\*</sup>, Ratna Dewi Kusumaningtyas <sup>b</sup>, Giuseppe Gozzelino <sup>a</sup>

<sup>a</sup> Dipartimento di Scienza Applicata e Tecnologia, Politecnico di Torino, Torino, Italy

<sup>b</sup> Chemical Engineering Department, Universitas Gadjah Mada, Yogyakarta, Indonesia

## ARTICLE INFO

### Article history:

Received 27 November 2013

Accepted 17 January 2014

Available online 24 January 2014

### Keywords:

Reactive distillation  
Fatty acid  
Process simulation  
Esterification  
Process intensification

## ABSTRACT

Process intensification through reactive distillation (RD) could be successfully applied to the esterification of long-chain fatty acids, which is a crucial step in the biodiesel synthesis. While previous literature reports are mainly focused on the esterification of short- to medium- fatty acids, oleic acid has been chosen as an example of a long chain one and different RD configurations were simulated and compared. The configuration with top external recycle proved to be the best solution since it allows the reaction to be conducted under a large methanol excess, even though the column is fed with stoichiometric reactants.

© 2014 The Korean Society of Industrial and Engineering Chemistry. Published by Elsevier B.V. All rights reserved.

## 1. Introduction

Esterification of fatty acids with alcohols is an important class of reactions due to the considerable industrial interest of organic esters, which can be used as solvents, surfactants, plasticizers in polymer processing or chemical intermediates [1]. The industrial use of organic esters ranges from the textile and rubber manufacturing to the food, cosmetic and pharmaceutical ones [2–4].

Recently, the esterification of fatty acids has become a crucial step in the synthesis of biodiesel, a promising alternative fuel. The biodiesel consists in a mixture of organic esters that can be obtained either by transesterification reactions of the triglycerides contained in vegetable oils and fats or by esterification reactions of fatty acids obtained through hydrolysis of vegetable oils [1,5]. In the first case, the “transesterification route”, the esterification of the free fatty acids contained in the triglyceride is an important preparatory reaction. In fact, the conventional transesterification process requires a pre-treatment of the triglyceride feedstock to reduce the free-fatty-acid content to a level lower than 1–2% to avoid undesired saponification reactions, which consume the transesterification catalyst, reduce the biodiesel yield and hinder the product separation process [6]. This point is particularly

important when triglyceride feedstocks with a high free-fatty-acid content, such as waste cooking oils [7–9], non edible oils [10], and fatty acid cuts [11,12], are used in order to achieve more sustainable pathways for biodiesel synthesis [13].

As far as the “esterification-route” is concerned, the biodiesel is synthesized through a two step process to avoid the above-cited drawbacks of the transesterification process. In the first step the triglycerides are hydrolyzed to fatty acids, which in the second are esterified to organic esters [14–16].

The esterification reaction between a fatty acid and the methanol, which is the most used alcohol in the biodiesel production, is a very slow, liquid-phase reaction, in which the chemical equilibrium limits the conversion of the reactants. To overcome these limitations and to achieve a high conversion, a catalyst together with a large excess of alcohol is required. Mineral acids, such as sulphuric acid and hydrochloric acid, or a strong organic acid, such as formic acid, can be used as liquid catalysts. Since they cause corrosion as well as separation problems, the development of heterogeneous catalysts with enhanced activity has become the main topic of current research on the subject. Ion-exchange resins containing sulfonic acid groups are widely proposed in the literature [17–19], while sulphated zirconia has recently received great attention due to its remarkable activity, selectivity, good thermal stability and reusability [20].

In a conventional continuous process, the esterification reaction of a fatty acid with methanol

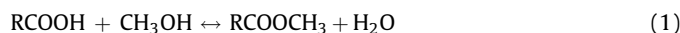

\* Corresponding author at: Dipartimento di Scienza Applicata e Tecnologia, Politecnico di Torino, Corso Duca degli Abruzzi, 24, Torino, Italy. Tel.: +39 0110904703.

E-mail address: [mauro.banchemo@polito.it](mailto:mauro.banchemo@polito.it) (M. Banchemo).



must be integrated with a methanol recycling system based on distillation units, because of the excess of this reactant required by the presence of the chemical equilibrium.

In order to improve the process, reaction and separation units can be combined in a single apparatus, a RD unit, designed as a single column divided into a reaction, a rectifying, and a stripping section, the former fed with a stoichiometric amount of reactants (Fig. 1). In such a way, a reduction of physical equipments is attained together with an improvement in the yield of the process, since the water produced in the reactive section is in situ removed from the liquid phase, thus driving the chemical equilibrium to the right.

Apart from the simplification of the separation system and the increase in conversion the RD can offer many other advantages such as improved selectivity, reduction in the catalyst requirement, heat integration benefits and control of hot spots and runaway reactions [21].

Experimental and simulation studies involving organic acid esterification are reported in the literature but are mainly limited to short- or medium-chain fatty acids, such as acetic [22], decanoic [23] and dodecanoic acid [24–26]. Only two simulations that involve long-chain fatty acids can be found in the literature [27,28]. In both cases, the simplifying assumptions are critical for an accurate modelling of a RD unit. In one case the authors assumed an homogeneous catalyzed system where chemical equilibrium was attained on each reactive tray [27]; in the other case a simplified kinetic model that considered the esterification reaction as a one-way irreversible reaction with a zero order dependence on methanol concentration was employed [28].

In this work, RD has been applied as a case-study to the esterification of oleic acid, a long-chain fatty acid that is also one of the most representative fatty acids in the composition of triglycerides of many biodiesel feedstocks [29]. The investigation of the RD esterification of a long-chain carboxylic acid with methanol is particularly interesting because it is one of the cases with the most unfavourable relative volatilities, where the reactants are the heaviest and the lightest components [30]. In addition the long-chain acid and its methyl ester exhibit a lower difference in vapour pressures with respect to short-chain systems so enhancing the complexity of their separation in the RD column. The process has been simulated with stoichiometric composition of the RD feedstock to verify the effectiveness of the RD under the most unfavourable conditions, that is, in the absence of the effect of

the large methanol excess that is commonly used to force the equilibrium towards the product formation [8,19,27,31].

The RD simulation set-up was based on the equilibrium stage model. The performances of different RD configurations were evaluated in the presence of a heterogeneous catalyst and compared with that of a conventional plug flow reactor (PFR) working at the same temperature of the reactive zone of the RD.

## 2. Physical properties, kinetics and chemical equilibrium of the selected system

The kinetic data for the reaction between oleic acid and methanol were taken from a literature model based on a direct and a reverse reaction whose rates are dependent on the concentration of all compounds and on the presence of an acid ion exchange resin as the catalyst [18].

The reaction rate fits the pseudo-homogeneous second-order equilibrium expressed by the equation:

$$r = (k_1 X_{OA} X_M - k_2 X_{MO} X_W) C_{cat} \quad (2)$$

where  $X_{OA}$ ,  $X_M$ ,  $X_{MO}$  and  $X_W$  are the mole fractions in the liquid phase of oleic acid, methanol, methyl oleate and water, respectively,  $C_{cat}$  is the concentration (mass/reaction volume) of the solid catalyst and  $r$  is expressed as (moles) (catalyst mass)<sup>-1</sup> (time)<sup>-1</sup>.

The kinetics of the oleic acid esterification with methanol is well fitted by this equation in the 50–85 °C temperature range and in the presence of the Relite CFS, an acid sulfonic resin, as a catalyst. The values of the pre-exponential factors ( $k_0$ ) and activation energies ( $E_a$ ) for the direct ( $k_1$ ) and reverse reactions ( $k_2$ ) are reported in Table 1, which also reports the enthalpy of the reaction and the normal boiling temperature of the components of the reacting system.

The maximum theoretical conversion that a conventional continuous reactor can reach for an infinite residence time, under stoichiometric and isothermal conditions, was considered the limit conversion, that is the conversion when the chemical equilibrium is reached. The results showed that the equilibrium conversion increases when temperature increases, as it can be expected from the endothermic character of the reaction. If the maximum working temperature is assumed to be 64.7 °C, which is the normal boiling point of the most volatile compound of the system (methanol), a maximum of 52% of conversion can be obtained.

## 3. Simulation set-up

All the RD simulations were carried out with a chemical process simulator (ASPEN Plus V 7.1). The RADFRAC steady-state model was used both for the RD columns and regular distillation columns. RADFRAC is a rigorous physical equilibrium stage model able to solve the set of equations that describe each equilibrium stage: material balances, enthalpy balances and phase equilibrium relations between the vapour and the liquid leaving the stage. The phase equilibrium was described assuming the vapour phase as ideal and the liquid phases as real, on the basis of the UNIQUAC model as it was suggested by Bathia and co-workers [32]. When the RD column was simulated, the pseudo-homogeneous kinetic model described by Eq. (2), which accounts for the chemical

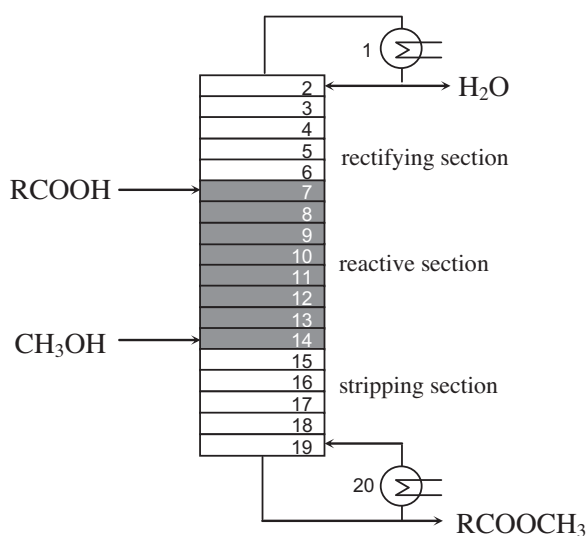

Fig. 1. Basic RD configuration for the oleic acid esterification with methanol (the stages are numbered according to Aspen notation).

Table 1  
Kinetic and thermodynamic parameters of the reacting system.

$k_1$ (mol cm <sup>3</sup> g <sub>cat</sub> <sup>-2</sup> min <sup>-1</sup> )	Ln $k_0$ = 12.93	$E_a$ (kcal/mol) = 14.00
$k_2$ (mol cm <sup>3</sup> g <sub>cat</sub> <sup>-2</sup> min <sup>-1</sup> )	Ln $k_0$ = 8.76	$E_a$ (kcal/mol) = 11.32
$\Delta H_r$ (kcal/mol)	2.68	
$T_{boil}$ (1 bar, °C)	Methanol = 64.7	Oleic acid = 359.8
	Water = 100.0	Methyl oleate = 343.8

**Table 2**  
Parameters for the basic RD simulation with stoichiometric reactant ratio.

Parameter	Value
Total number of stages	20
Number of reactive stages	8 (from 7 to 14)
Catalyst concentration in each reactive stage	0.32 kg/l
Oleic acid feed stage and temperature	Stage 7 at 60 °C
Methanol feed stage and temperature	Stage 14 at 64.7 °C
Total feed of reactants	30 mol/h
Pressure	Atmospheric
Type of condenser (stage 1)	Total
Type of reboiler (stage 20)	Kettle

reaction rate in the liquid phase, was included in the set of equations that described the reactive section.

The main parameters of the basic RD column (Fig. 1) such as the number of stages, the catalyst concentration, etc., are reported in Table 2 and were suggested by the work of Steinigeweg and Gmehling [24] who investigated the esterification of decanoic acid with methanol. The temperature of the reactive zone was limited by the boiling temperature of the methanol (64.7 °C). Since the reaction occurs in the liquid phase, higher temperatures would strongly reduce the reaction rate due to the reduction in the concentration of methanol in the liquid phase.

#### 4. Results and discussion

To compare the results obtained in the oleic acid esterification by different RD configurations, an isothermal plug flow reactor operating in the conditions of the reactive section of the RD column reported in Table 2 was simulated as a reference. The mass and enthalpy balances, solved through the PLUGR model of ASPEN, resulted in a reactant conversion of 50%, a value very close to the equilibrium conversion (52% at 64.7 °C).

##### 4.1. The basic RD unit

A basic RD configuration permits the equilibrium-limited conversion to be overcome because of the coupling of the reaction with product separation and of the presence of the top reflux ratio (RR). In a RD configuration, the reflux acts like an internal recycle of a methanol-water mixture whose composition depends on the adopted RR: the higher the RR, the lower the methanol fraction in the reflux. Lower RRs result in higher conversions because of the lower amount of water entering the reactive sections thus preventing the shift of the chemical equilibrium towards the reactants [24]. A maximum of conversion can be reached by lowering the reflux ratio up to values where reflux can be neglected (RR = 0.01) as it is shown in Fig. 2 whose simulations were obtained for a RD column with the reactive section located between stages 2 and 9. Fig. 2 also shows the trend of the total heat requirement of the column versus the RR and points out that operating at low RR also reduces the energy demand per mole of methyl oleate (MO).

The position of the reactive section inside the column is a design parameter that can be varied to optimize the results. This was investigated keeping the total number of trays to 20 and those of the reacting ones to 8 but changing their position inside the column. Obviously, when the reactive section is moved up, i.e. stages 3–10 instead of 7–14 in the basic RD in Fig. 1, the number of rectifying stages is decreased and the number of the stripping ones is increased.

The results, reported in Fig. 3, show that the conversion increases when the reactive section is moved up. A 73% conversion is obtained when the rectifying section is removed completely from the column or, in other words, when the reactive section is localized in stages 2–9. This increase in conversion can be

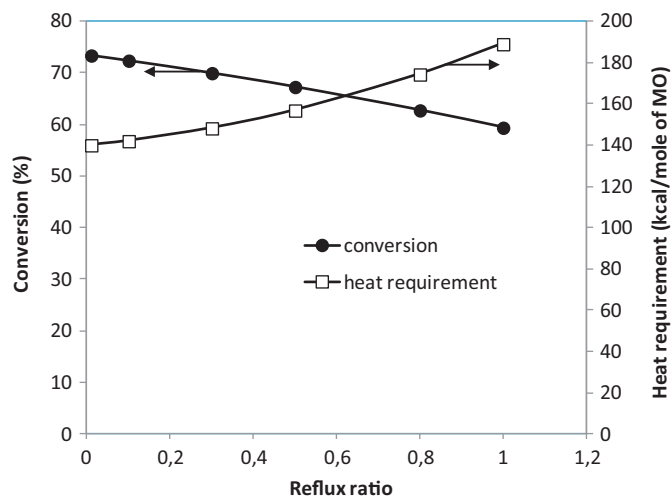

**Fig. 2.** Conversion and heat requirement plotted versus reflux ratio for the basic RD unit (reactive stages from 2 to 9).

explained by considering that the liquid phase in the rectifying section contains high amounts of water. The composition profiles obtained from the simulations showed that the higher the number of trays in the rectifying zone the richer the liquid entering the reactive zone is in water. As a consequence, the removal of the rectifying section has a beneficial effect on the displacement of the chemical equilibrium in the reactive zone.

It was concluded that the RD column with a negligible reflux and reactive stages from 2 to 9 was the basic configuration that gives the maximum conversion (73%). The temperature and the reaction rate profiles of this set-up are reported in Fig. 4 while Fig. 5 shows the vapour and liquid composition along the column.

The column is operated in the temperature range of 64–318 °C but the reaction is conducted in a nearly isothermal condition since the temperature range in the reactive section does not display a large variation (64–72 °C, Fig. 4a).

In the liquid phase (Fig. 5a) of the reactive section the concentration of methanol increases from the top to the bottom while that of the other reactant, the acid, shows the opposite trend: at stage 4 the molar concentrations of the two reactants are equal (stoichiometric conditions). In other words, with reference to the methanol, the reactive stages 2 and 3 operated with a defect and those from 5 to 9 operated with an excess of this reactant. A similar

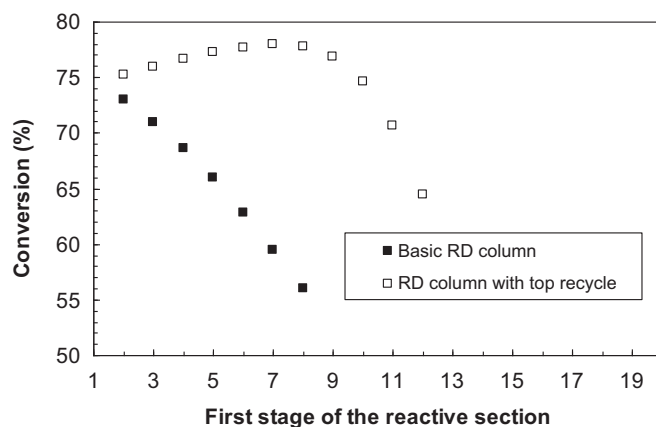

**Fig. 3.** Conversion at different positions in the reactive section for the basic RD unit and the RD unit with top recycle. Equilibrium stages, or column plates, are numbered from the top of the column (RR = 0.01, number of reactive stages = 8).

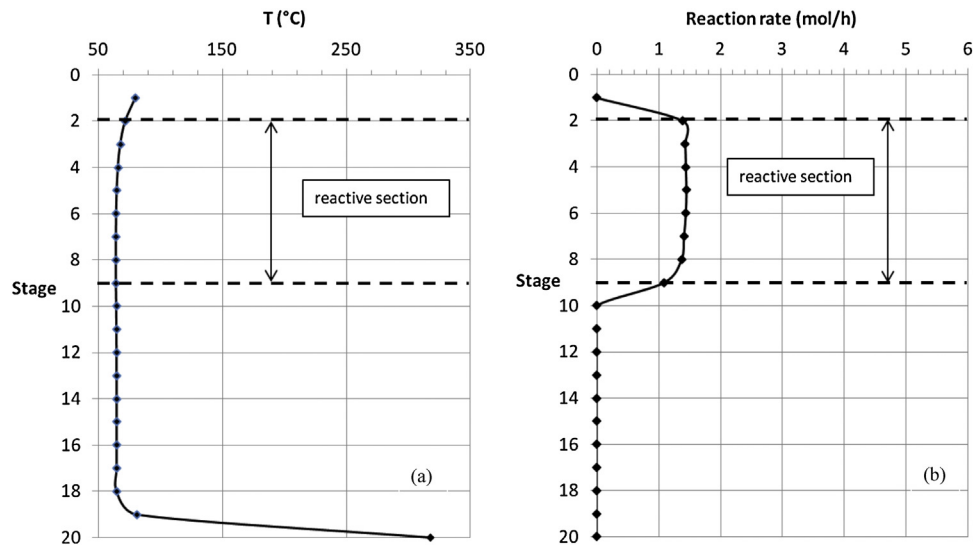

Fig. 4. Temperature (a) and reaction rate (b) profiles along the basic RD unit (RR = 0.01, reactive stages from 2 to 9).

concentration trend can also be observed as far as the products, i.e. water and ester, is concerned: the water decreases its concentration from stage 2 to 9 while that of the ester increases.

The almost isothermal temperature profile and the “crisscross” trend of the concentrations of both reactants and products in the liquid phase of the reactive section result in approximately constant values of the direct and reverse contributions to the reaction kinetics in Eq. (2), which gives reason of the flat pattern of the reaction rate shown in Fig. 4b.

As far as the liquid phase at the top of the column is concerned it can be observed that, even though it mainly contains water, the methanol content is not negligible. Similarly the liquid phase at the bottom is not pure ester but contains large amounts of un-reacted acid. For these reasons, in order to increase the reactant conversion, the RD unit was tested after introduction of appropriate auxiliary distillation columns to recycle the un-reacted methanol and oleic acid from the top and bottom streams, respectively.

#### 4.2. RD column with a top external recycle

The first goal was to recover and recycle the un-reacted methanol in the top stream. As explained in the previous section,

this cannot be obtained by increasing the RR because methanol is the lowest boiling component and a greater amount of water in the reflux would result in an undesired shift in the chemical equilibrium. The introduction of a distillation unit, fed with the top stream of the RD column, is the first obvious choice that could allow water to be removed from methanol before the recycling step. The simulations showed that this is not a suitable solution since a huge number of separating stages would be required to obtain sufficient separation of the water.

The economy of the process suggests enriching the recycling stream with methanol by partially condensing the vapours that leave the RD column, that is the configuration reported in Fig. 6, in which a partial condenser substitutes the total one of the basic RD column. The vapour phase leaving the partial condenser can be mixed with the fresh methanol feed at its boiling point and fed at the lowest stage of the reactive section. This solution allows the un-reacted methanol to be recycled and reduces the water amount in the reflux.

In this configuration, the position of the reactive section and the RR play different roles. The conversion shows a maximum when the position of the reacting zone is changed, with the first catalyst layer on the stage 7 or 8, as reported in Fig. 3. With the reactive

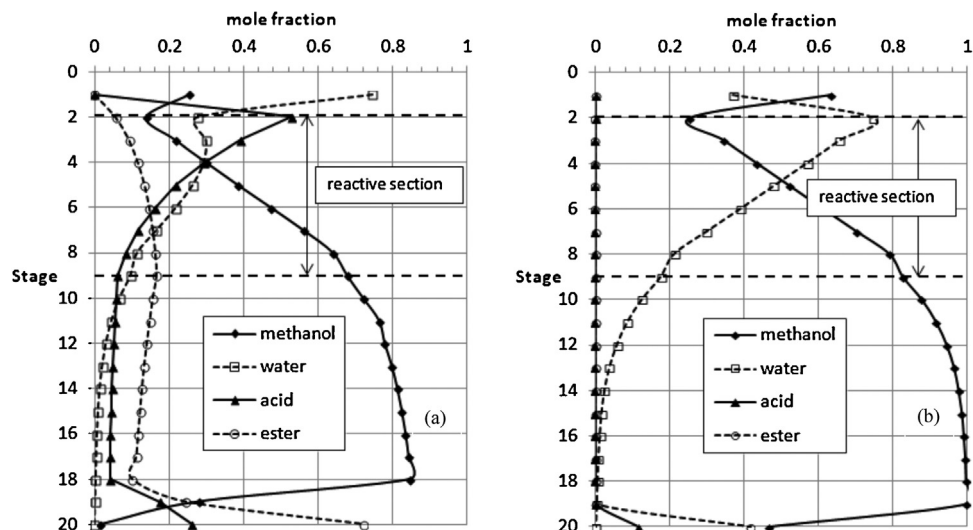
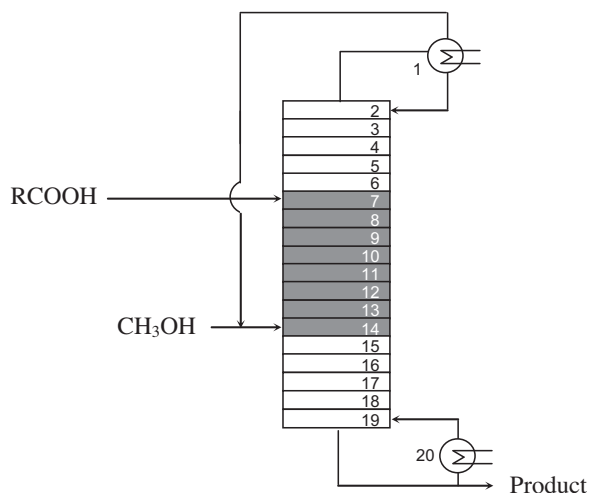

Fig. 5. Liquid (a) and vapour (b) molar composition profiles along the basic RD unit (RR = 0.01, reactive stages from 2 to 9).

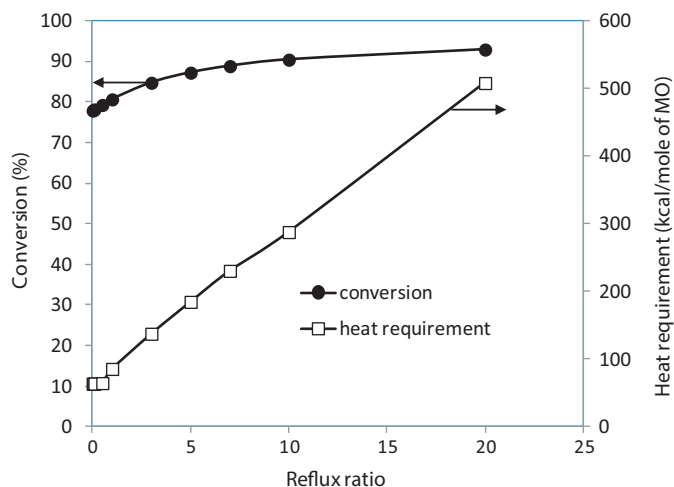

**Fig. 6.** RD unit with top external recycle (the stages are numbered according to Aspen notation).

zone located in the optimal position, the conversion increases when the RR is increased (Fig. 7). This trend is the opposite with respect to that reported for the basic RD unit in Fig. 2. In fact, the presence of the partial condenser with the consequent recycle of a methanol-rich vapour stream changes the temperature and composition profiles inside the column and tends to reduce the liquid flow rate in the rectifying and reactive zone. Since the reaction occurs in the liquid phase, higher RR are required to achieve significant conversions.

Fig. 7 also shows the trend of the total heat requirement of the column versus the RR. A reference value of 10 was chosen for the RR, which corresponds to a conversion of 90% and an energy demand of 287.3 kcal/mol of methyl oleate. A further increase of the RR was not considered worthwhile since a slight increase in conversion results in a huge energy demand as it is shown in Fig. 7.

Fig. 8 reports the temperature and reaction rate profiles of the RD unit with top external recycle when it is operated under a RR of 10 and with reactive stages from 7 to 14. The column operates in a temperature range of 64–126 °C, that is narrower than that of the basic RD configuration in Fig. 4, but a similar temperature plateau is evident in the reactive section. On the contrary, the reaction rate profile shows quite a different trend since it exhibits a sharp maximum at the beginning of the reactive section (stage 7).



**Fig. 7.** Conversion and heat requirement plotted versus reflux ratio for the RD unit with top recycle (reactive stages from 7 to 14).

The different behaviour of this RD configuration is connected with a different trend in the vapour and liquid composition along the column (Fig. 9). Both the liquid and vapour phases in the rectifying section mainly contain methanol while the water fraction is negligible. With respect to the situation depicted in Fig. 5, the concentration of methanol in the liquid phase of the reactive section is always higher than that of the acid and this results in an excess of methanol that helps shifting the chemical equilibrium to the right. In this way, despite the column is fed with a stoichiometric ratio between the reactants, the advantage of carrying out the reaction in the presence of a large excess of alcohol is realized, which is the solution usually adopted in conventional processes to shift the chemical equilibrium towards the products.

The composition pattern of the liquid phase in the reactive section (Fig. 9a) explains the reaction rate profile reported in Fig. 8. The concentration of methanol and ester are approximately constant all along the reactive stages, while the mole fraction of the acid is strongly decreased from stage 7 to 14 and that of water is almost doubled. On the edge of the reactive section (stage 7) the reaction rate is maximum due to the large methanol excess and the low amount of products. In the following stages, the acid depletion and the water enrichment of the liquid phase result in a slowing down of the direct reaction rate and in an increasing importance of the reverse reaction.

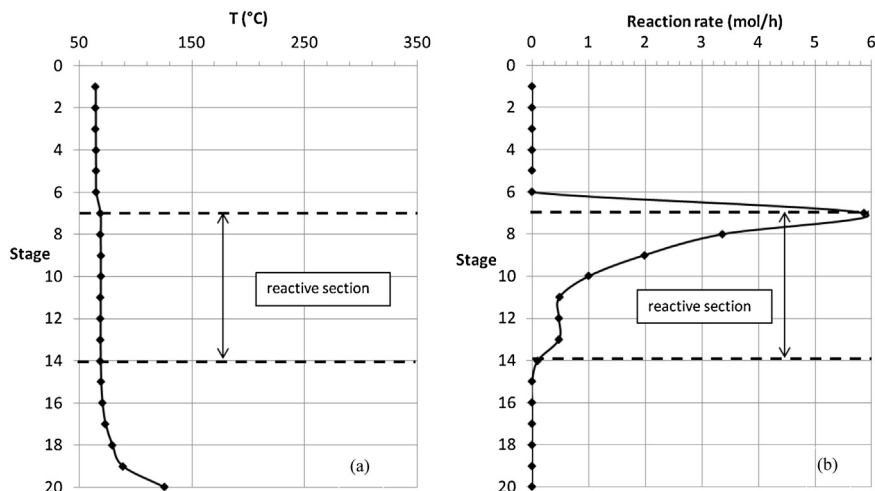

**Fig. 8.** Temperature (a) and reaction rate (b) profiles along the RD unit with top recycle (RR = 10, reactive stages from 7 to 14).

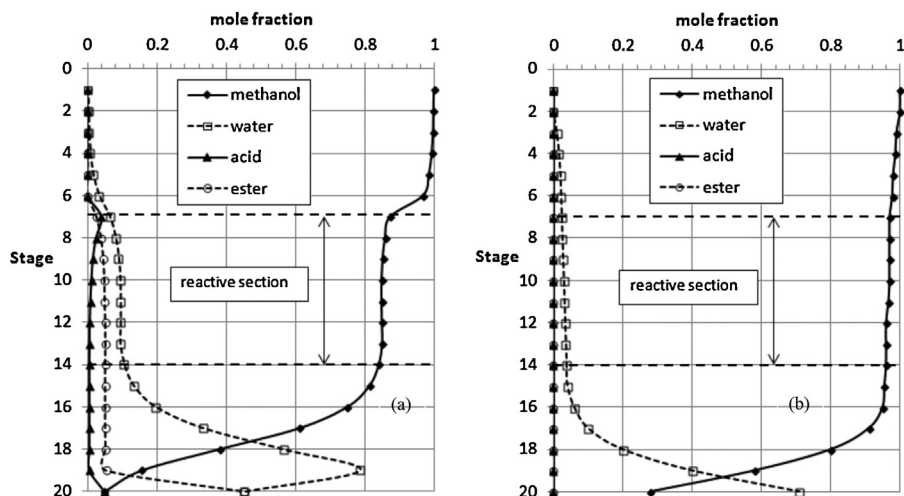

Fig. 9. Liquid (a) and vapour (b) molar composition profiles along the RD unit with top recycle (RR = 10, reactive stages from 7 to 14).

#### 4.3. RD unit with top and bottom recycles

The configuration of the RD column with top external recycle was fixed at the optimal working conditions reported in the previous section (RR = 10 and reactive section located in stages 7–14), while two different solutions were analyzed for bottom recycle.

In the first solution, here denoted as “Case A”, an auxiliary column performs a separation of a water-rich stream, which is purged, and an acid-rich stream, which is recovered and recycled (Fig. 10). The auxiliary column is equipped with 10 equilibrium stages, a total condenser (stage 1) and a Kettle reboiler (stage 10). The auxiliary column is operated under an RR = 5 and is fed at stage 5 by the side stream from the last stage of the RD unit.

The results, reported in Table 3, show that an overall conversion of 91% is obtained, a result that does not significantly improve the performance of the process, if compared to the RD unit with only the top external recycle (90%).

As can be seen in Table 3, the presence of the auxiliary column mainly affects the composition of the product stream, which increases the ester purity. In the basic RD unit the water is collected in the top distillate stream, which is removed from the column, while it is collected in the bottom products in the other configurations. The presence of water as an impurity compound of the product streams should not be considered a drawback because it can be easily separated, due to the liquid–liquid natural phase split that occurs between the water and the organic components of the bottom.

The solution proposed in Fig. 10 does not appear advantageous with respect to the RD unit with only the top external recycle since the conversion improvement is negligible. Moreover, the increase in the product purity, which is simply the consequence of a lower water content, does not justify the use of a distillation unit, more expensive than a simple decanter. Furthermore, the water-rich distillate contains a non-negligible amount of methanol (15%, w/w), which is lost.

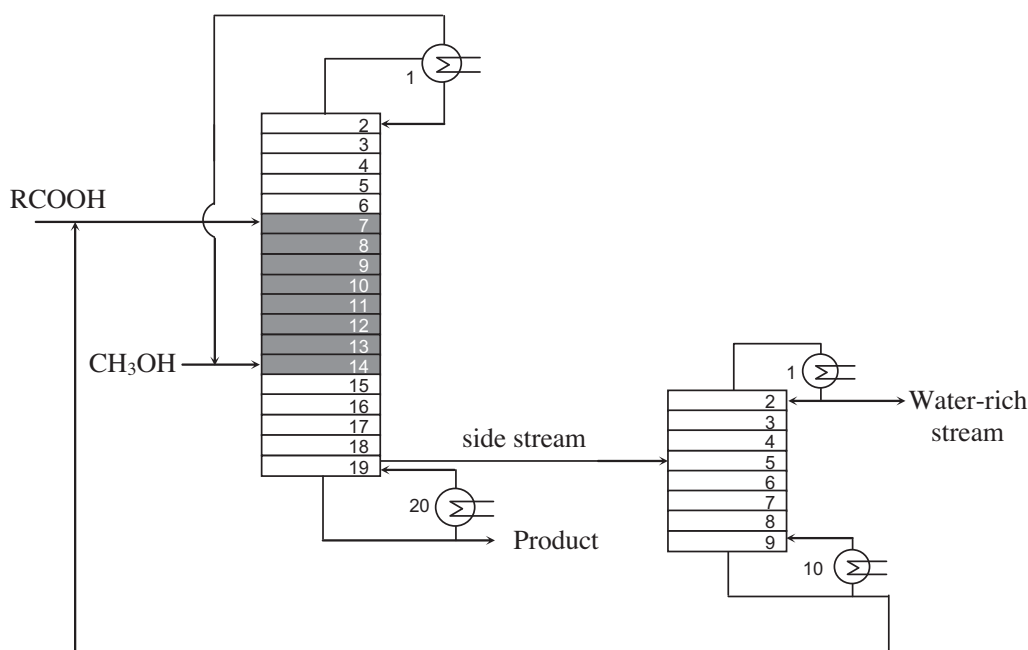

Fig. 10. RD unit with top and bottom recycle – Case A (the stages are numbered according to Aspen notation).

**Table 3**

Comparison between the conversion, purity and heat requirement results of the different RD configurations and the plug-flow reactor with methanol recycle.

	Basic RD	RD with top recycle	RD with top and bottom recycle		Plug-flow reactor with methanol recycle
			(Case A)	(Case B)	
RD unit parameters:					
RR	0.01	10	10	10	–
Type of condenser	Total	Partial	Partial	Partial	–
Reactive stages	2–9	7–14	7–14	7–14	–
Reactant conversion	73%	90%	91%	91%	70%
Product overall flow-rate (mol/h)	15.2	30	16.7	19.4	30
Product purity (ester content), w/w	75%	85%	91%	88%	65%
Main impurities in the product stream, w/w	Acid (25%) Water (0%)	Acid (9%) Water (5%)	Acid (8%) Water (1%)	Acid (9%) Water (2%)	Acid (27%) Water (4%)
Water-rich stream overall flow-rate (mol/h)	–	–	13.3	–	–
Water-rich stream composition, w/w	–	–	Water (85%) Methanol (15%)	–	–
Secondary product overall flow-rate (mol/h)	–	–	–	10.6	–
Secondary product composition, w/w	–	–	–	Acid (7%) Water (38%) Ester (55%)	–
Heat requirement (kcal/mol of MO)	139.8	287.3	312.5	317.6	218.4

In the second solution, here denoted as “Case B”, the auxiliary column performs a methanol recovery at the top and produces a secondary product stream at the bottom (Fig. 11). This configuration was studied to overcome the methanol loss pointed out in the previous solution. The total number of stages of the auxiliary column is equal to 20, with a partial condenser (stage 1) and a Kettle reboiler (stage 20). The auxiliary column is operated at RR = 5 and is fed at stage 9 by the side stream from the last stage of the RD unit.

The results reported in Table 3 show that the reactant conversion and the main product stream composition are similar to those of the previous configuration. The secondary product

stream obtained at the bottom of the auxiliary column contains a large amount of water, which, however, would require a decanter for ester recovery. It can be concluded that this configuration does not offer any advantages with respect to the RD unit with only the top external recycle.

#### 4.4. Comparison between the RD configurations and the isothermal plug flow reactor with methanol recycle

The previous discussion showed that the RD unit with the top external recycle obtained through a partial condenser, resulted in the best conversion improvement for the oleic acid RD

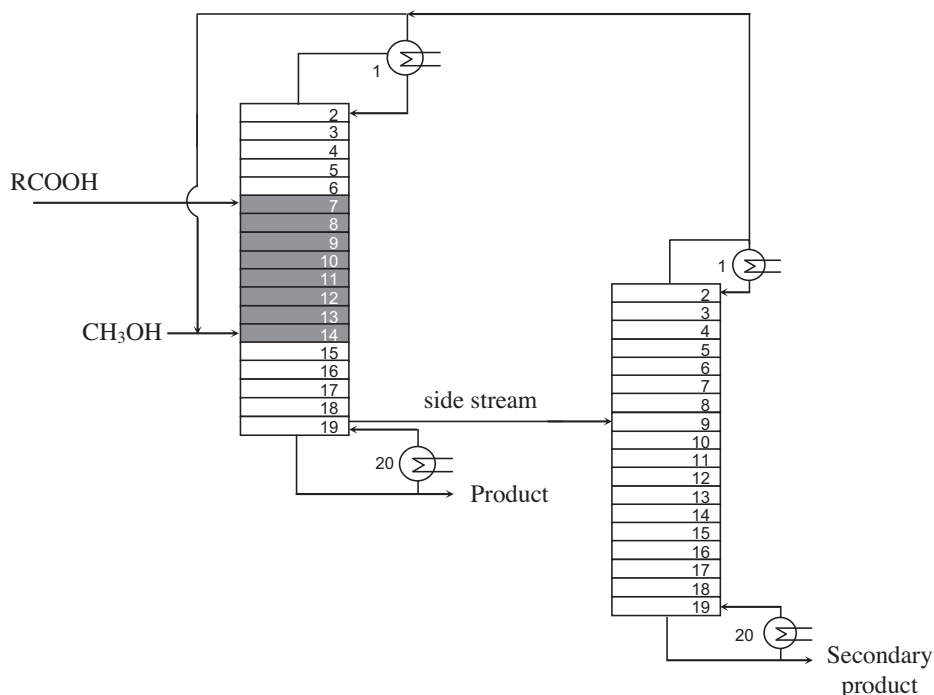

Fig. 11. RD unit with top and bottom recycle – Case B (the stages are numbered according to Aspen notation).



esterification process with methanol. From a chemical engineering point of view, the more conventional replica of the continuous RD process with external recycle of methanol is a PFR coupled with a distillation column for separation and recycling of the methanol. For comparative purposes, the more conventional process was simulated with the same working parameters of the RD column, that is feedstock molar flow and composition, catalyst amount, pressure and temperature. The auxiliary column, planned with 20 stages, a partial condenser (stage 1) and a Kettle reboiler (stage 20), was operated at a RR = 5 and fed at stage 9 by the output stream from the plug flow reactor. The bottom stream of the auxiliary column is the product of the process while the top methanol-rich distillate is mixed with the fresh feed of the PFR.

The simulation results obtained for the PFR with methanol recycle are reported in Table 3 and can be compared with those of the different RD configurations. A conversion of 70% was obtained, which is higher than that obtained with the PFR alone without any recovery unit (50%), but lower than those obtained for all the examined RD configurations. This confirms that the coupling of the reaction and separation steps in a single unit has beneficial effects on processes controlled by a chemical equilibrium.

As far as the most appropriate design of the RD unit is concerned, the peculiarity of the reacting system has to be kept in mind. Specific strategies are required with respect to conventional RD columns since the benefit of driving the chemical equilibrium to the right by coupling the reaction with in situ product removal can be limited by the physical properties of the reaction components. In this case, for example, the fact that the reactant methanol is the most volatile compound limits the performance of the basic RD solution since this reactant has the tendency to be removed from the reactive zone and be collected at the top of the column.

On the other hand the RD unit with top external recycle allows the most volatile reactant to be sent back to the reactive zone forcing the system to work with an excess of this reactant flowing in a countercurrent arrangement with respect to the other reactant. This is a suitable way to drive the chemical equilibrium to the right.

Key parameters in the design of the RD unit with top recycle are the RR and the position of the reactive zone, which affect the performance of the column in different ways with respect to the conventional RD one. This is due to the change in the composition profiles inside the column, with the drawback of the presence of the secondary product, the water, at the bottom of the column. The consequent decrease in the purity of the main product, the methyl oleate, would require additional distillation units in the case of a homogeneous system, but only a gravity settler in this two liquid phase system.

## 5. Conclusion

The application of the reactive distillation technology has been analyzed by means of process simulation for the esterification of oleic acid with methanol. Simulations with a long-chain fatty acid and a pseudo-homogeneous second-order equilibrium kinetics are reported for the first time. Several different RD units were simulated and compared. The RD column with a top external recycle allowed us to obtain a 90% reactant conversion and proved to be the best solution among those examined. It can be obtained from the conventional RD unit by only substituting the top total condenser with a partial one without adding any auxiliary

columns. In these conditions the reaction occurs under a large methanol excess even though the column is fed with stoichiometric ratio of the reactants. A consequence of the proposed set-up is that water is found in the bottom stream instead of being recovered as the top distillate. This aspect should not be considered a drawback since a simple decanter can split the two liquid phase system and allow the recovery of the ester.

In the optimized conditions, the RD process with stoichiometric ratio between the reactants in the feed gives yields of about 90%, higher than those obtained in the equilibrium constrained conditions (52%) or in a comparable conventional continuous process (70%).

This work is just an initial design suitable for initializing a formal optimization procedure and future simulation tests can be run operating under higher pressures, which would allow achieve higher temperature levels in the reactive section, or in the presence of heterogeneous catalysts with higher activity. This goal can only be achieved after specific experimental tests at higher temperatures or with different catalysts are performed to obtain the appropriate kinetic models, which at the moment are not available in the literature.

## References

- [1] S.D.T. Barros, A.V. Coelho, E.R. Lachter, R.A.S. San Gil, K. Dahmouche, M.I. Pais da Silva, A.L.F. Souza, *Renew. Energy* 50 (2013) 585.
- [2] V. Brahmkhatri, A. Patel, *Fuel* 102 (2012) 72.
- [3] F. Chemat, M. Poux, S.A. Galemia, *J. Chem. Soc. Perkin Trans. 2* (11) (1997) 2371.
- [4] A. Zaidi, J.L. Gainer, G. Carta, A. Mrani, T. Kadiri, Y. Belarbi, A. Mir, *J. Biotechnol.* 93 (2002) 209.
- [5] E. Lotero, Y. Liu, D.E. Lopez, K. Suwannakarn, D.A. Bruce, J.G. Goodwin Jr., *Ind. Eng. Chem. Res.* 44 (2005) 5353.
- [6] I.M. Atadashi, M.K. Aroua, A. Abdul Aziz, *Renew. Energy* 36 (2011) 437.
- [7] Z. Yaakob, M. Mohammad, M. Alherbawi, Z. Alam, K. Sopian, *Renew. Sust. Energy Rev.* 18 (2013) 184.
- [8] G.L. Maddikeri, A.B. Pandit, P.R. Gogate, *Ind. Eng. Chem. Res.* 51 (2012) 14610.
- [9] S.M. Hingu, P.R. Gogate, V.K. Rathod, *Ultrasound. Sonochem.* 17 (2010) 827.
- [10] V.L. Gole, P.R. Gogate, *Chem. Eng. Process.* 53 (2012) 1.
- [11] V.G. Deshmane, P.R. Gogate, A.B. Pandit, *Ind. Eng. Chem. Res.* 48 (2009) 7923.
- [12] M.A. Kelkar, P.R. Gogate, A.B. Pandit, *Ultrasound. Sonochem.* 15 (2008) 188.
- [13] D. Kralisch, C. Staffel, D. Ott, S. Bensaid, G. Saracco, P. Bellantoni, P. Loeb, *Green Chem.* 15 (2013) 463.
- [14] D. Kusdiana, S. Saka, *Appl. Biochem. Biotechnol.* 115 (2004) 781.
- [15] A.A. Kiss, A.C. Dimian, G. Rothenberg, *Energy Fuels* 22 (2008) 598.
- [16] L.L.L. Rocha, A.L.D. Ramos, N.R. Antoniosi Filho, N.C. Furtado, C.A. Taft, D.A.G. Aranda, *Lett. Org. Chem.* 7 (2010) 571.
- [17] J. Liljia, D.Y. Murzin, T. Salmi, J. Aumo, P. Maki-Arvela, M. Sundell, *J. Mol. Catal. A: Chem.* 182–183 (2002) 555.
- [18] R. Tesser, M. Di Serio, M. Guida, M. Nastasi, E. Santacesaria, *Ind. Eng. Chem. Res.* 44 (2005) 7978.
- [19] C.S. Caetano, L. Guerreiro, I.M. Fonseca, A.M. Ramos, J. Vital, J.E. Castanheiro, *Appl. Catal. A: Gen.* 359 (2009) 41.
- [20] K. Suwannakarn, E. Lotero, K. Ngaosuwarn, J.G. Goodwin Jr., *Ind. Eng. Chem. Res.* 48 (2009) 2810.
- [21] R. Taylor, R. Krishna, *Chem. Eng. Sci.* 55 (2000) 5183.
- [22] A. Arpornwichanop, K. Koomsup, S. Assabumrungrat, *J. Ind. Eng. Chem.* 14 (2008) 796.
- [23] A.C. Dimian, C.S. Bildea, F. Omota, A.A. Kiss, *Comput. Chem. Eng.* 33 (2009) 743.
- [24] S. Steinigeweg, J. Gmehling, *Ind. Eng. Chem. Res.* 42 (2003) 3612.
- [25] A.A. Kiss, *Fuel Process. Technol.* 92 (2011) 1288.
- [26] A.A. Kiss, F. Omota, A.C. Dimian, G. Rothenberg, *Top. Catal.* 40 (2006) 141.
- [27] E. Cossio-Vargas, S. Hernandez, J.G. Segovia-Hernandez, M.I. Cano-Rodriguez, *Energy* 36 (2011) 6289.
- [28] G.D. Machado, D.A.G. Aranda, M. Castier, V.F. Cabral, L. Cardozo-Filho, *Ind. Eng. Chem. Res.* 50 (2011) 10176.
- [29] L. Lin, Z. Cunshan, S. Vittayapadung, S. Xiangqian, D. Mingdong, *Appl. Energy* 88 (2011) 1020.
- [30] H. Chen, K. Huang, W. Liu, L. Zhang, S. Wang, S.J. Wang, *AICHE J.* 59 (2013) 2015.
- [31] D. Rattanaphra, A.P. Harvey, A. Thanapimmetha, P. Srinophakun, *Renew. Energy* 36 (2011) 2679.
- [32] S. Bhatia, A.R. Mohamed, A.L. Ahmad, S.Y. Chin, *Comput. Chem. Eng.* 31 (2007) 1187.

# Terindeks Scopus SJR 0.865 (2014) dan SCIE Web of Science IF 3.512 (2014)

## 1. SCOPUS

Source Details : Scopus.com  
Coverage : from 1996 to Present

The screenshot shows the Scopus Source Details page for the Journal of Industrial and Engineering Chemistry. The page includes the journal title, Scopus coverage years (1996 to Present), ISSN (1226-086X), and subject area (Chemical Engineering: General Chemical Engineering). It also displays key metrics: CiteScore 2020 (9.6), SJR 2020 (1.103), and SNIP 2020 (1.292). A notification banner at the bottom explains the improved CiteScore methodology for 2020, which counts citations from 2017-2020. Below the notification, the CiteScore 2020 calculation is shown as 9.6 = 20,610 Citations 2017 - 2020 / 2,143 Documents 2017 - 2020, and the CiteScoreTracker 2021 is shown as 9.7 = 19,379 Citations to date / 2,005 Documents to date.

Scopus Preview

Author search Sources

### Source details

Feedback > Compare sources >

#### Journal of Industrial and Engineering Chemistry

Scopus coverage years: from 1996 to Present  
ISSN: 1226-086X  
Subject area: [Chemical Engineering: General Chemical Engineering](#)  
Source type: Journal

[View all documents >](#) [Set document alert](#) [Save to source list](#) [Source Homepage](#)

CiteScore 2020 [ⓘ](#)  
**9.6**

SJR 2020 [ⓘ](#)  
**1.103**

SNIP 2020 [ⓘ](#)  
**1.292**

CiteScore CiteScore rank & trend Scopus content coverage

**i** Improved CiteScore methodology [×](#)

CiteScore 2020 counts the citations received in 2017-2020 to articles, reviews, conference papers, book chapters and data papers published in 2017-2020, and divides this by the number of publications published in 2017-2020. [Learn more >](#)

CiteScore 2020 [⌵](#)

**9.6** =  $\frac{20,610 \text{ Citations } 2017 - 2020}{2,143 \text{ Documents } 2017 - 2020}$   
Calculated on 05 May, 2021

CiteScoreTracker 2021 [ⓘ](#)

**9.7** =  $\frac{19,379 \text{ Citations to date}}{2,005 \text{ Documents to date}}$   
Last updated on 04 August, 2021 - Updated monthly

CiteScore rank 2020 [ⓘ](#)



# Scimago Journal & Country Rank

also developed by

**SJR** Scimago Journal & Country Rank

Home Journal Rankings Country Rankings Viz Tools Help About Us

←

Ads by Google

Stop seeing this ad Why this ad? ⓘ

## Journal of Industrial and Engineering Chemistry

<b>COUNTRY</b>  South Korea   Universities and research institutions in South Korea	<b>SUBJECT AREA AND CATEGORY</b>  Chemical Engineering └ Chemical Engineering (miscellaneous)	<b>PUBLISHER</b>  Korean Society of Industrial Engineering Chemistry	<b>H-INDEX</b>  <b>97</b>
<b>PUBLICATION TYPE</b>  Journals	<b>ISSN</b>  1226086X	<b>COVERAGE</b>  1996-2020	<b>INFORMATION</b>  <a href="#">Homepage</a>

## SJR Information

**SJR = 0.865 (2014)**

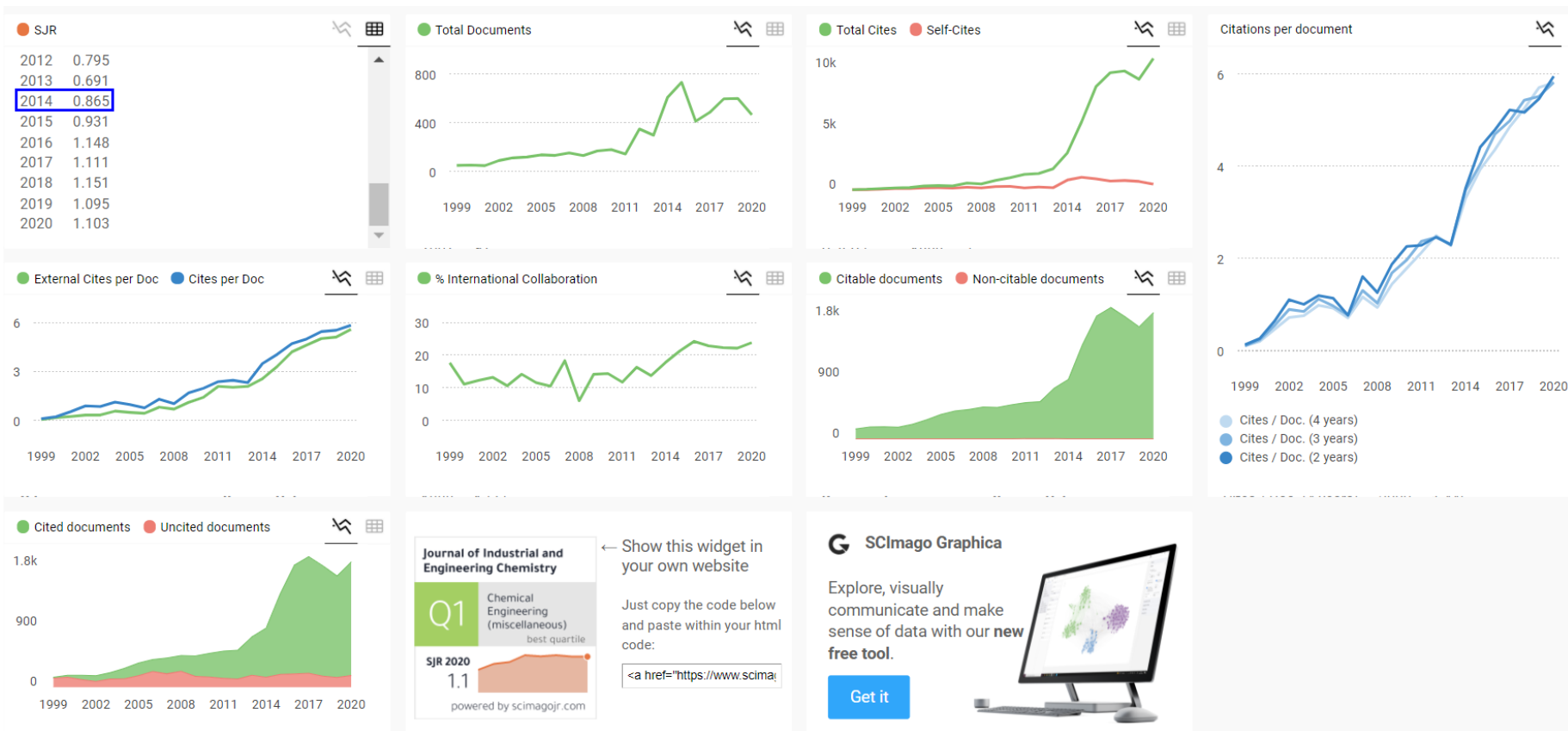

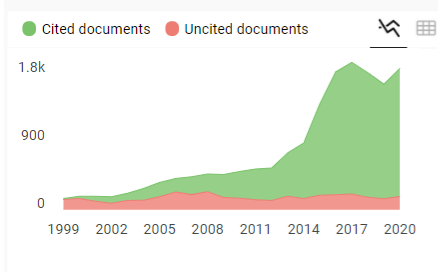
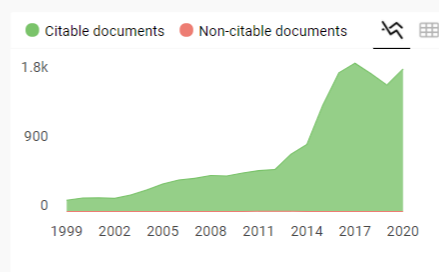
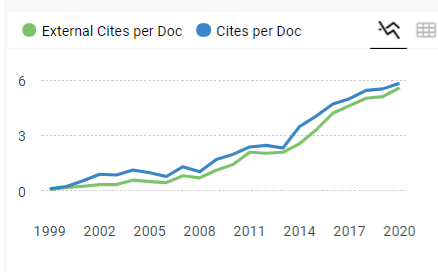
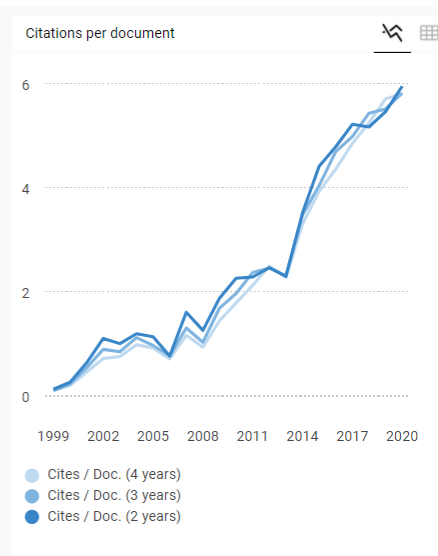
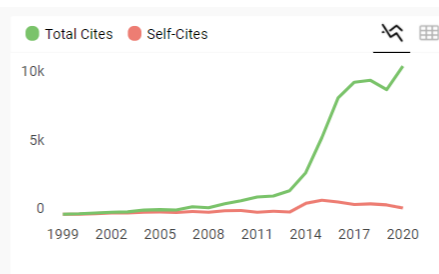
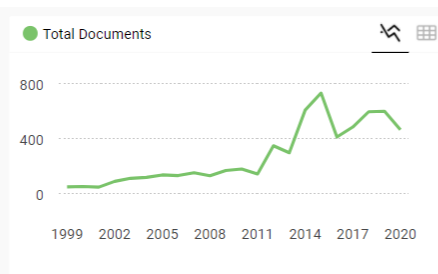
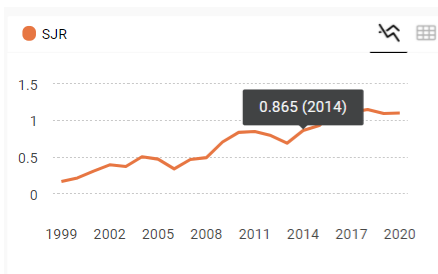

**Journal of Industrial and Engineering Chemistry**

← Show this widget in your own website

Q1 Chemical Engineering (miscellaneous) best quartile

SJR 2020 1.1

powered by scimagojr.com

Just copy the code below and paste within your html code:

```
<a href="https://www.scima
```

**SCImago Graphica**

Explore, visually communicate and make sense of data with our new free tool.

[Get it](#)

## Quartile Information

Quartile = Q1 (2014)

### Quartiles

Chemical Engineering (miscellaneous)	2011	Q1
Chemical Engineering (miscellaneous)	2012	Q1
Chemical Engineering (miscellaneous)	2013	Q1
Chemical Engineering (miscellaneous)	2014	Q1
Chemical Engineering (miscellaneous)	2015	Q1
Chemical Engineering (miscellaneous)	2016	Q1
Chemical Engineering (miscellaneous)	2017	Q1
Chemical Engineering (miscellaneous)	2018	Q1
Chemical Engineering (miscellaneous)	2019	Q1
Chemical Engineering (miscellaneous)	2020	Q1

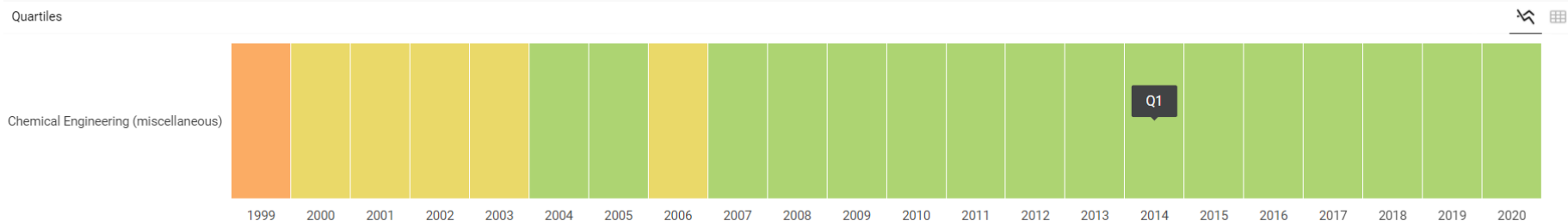

## 2. Terindeks WoS (Science Citation Index Expanded) Impact Factor = 3.512 (2014)



Master Journal List

[Search Journals](#) [Match Manuscript](#) [Downloads](#) [Help Center](#)

[Login](#) [Create Free Account](#)

 The power of the Web of Science™ on your mobile device, wherever inspiration strikes. [Dismiss](#) [Learn More](#)

Already have a manuscript? 

Use our Manuscript Matcher to find the best relevant journals!

[Find a Match](#)

### Refine Your Search Results

[Search](#) Sort By: [Relevancy](#)

### Search Results

Found 3,868 results (Page 1) [Share These Results](#)

### Did you mean this journal?

**JOURNAL OF INDUSTRIAL AND ENGINEERING CHEMISTRY**

Publisher: ELSEVIER SCIENCE INC , STE 800, 230 PARK AVE, NEW YORK, USA, NY, 10169

ISSN / eISSN: 1226-086X / 1876-794X

Web of Science Core Collection: Science Citation Index Expanded

Additional Web of Science Indexes: Current Contents Engineering, Computing & Technology | Current Contents Physical, Chemical & Earth Sciences | Essential Science Indicators

[Share This Journal](#) [View profile page](#)

### Filters

[Clear All](#)

- Web of Science Coverage
- Open Access 
- Category
- Country / Region
- Language
- Frequency

# Journal Impact Factor <sup>①</sup>

The Journal Impact Factor (JIF) is a journal-level metric calculated from data indexed in the Web of Science Core Collection. It should be used with careful attention to the many factors of volume of publication and citations characteristics of the subject area and type of journal. The Journal Impact Factor can complement expert opinion and informed peer review. In the case of individual researchers, institutions, or articles, it is inappropriate to use a journal-level metric as a proxy measure. [Learn more](#)

2020 JOURNAL IMPACT FACTOR

**6.064**

[View calculation](#)

JOURNAL IMPACT FACTOR

**5.77**

[View calculation](#)

## Journal Impact Factor Trend 2020

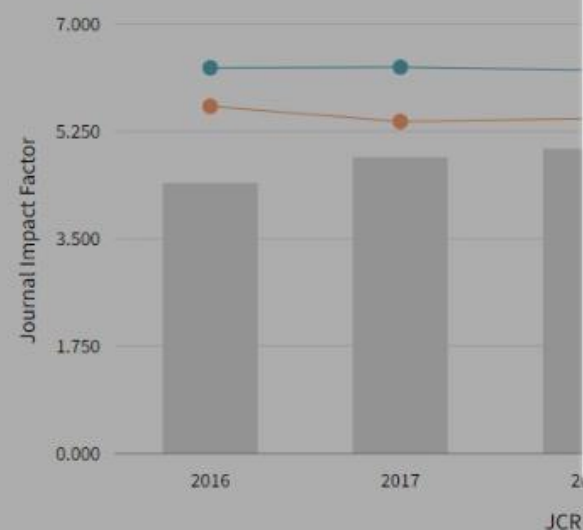

● Journal Impact Factor ● ENGINEERING, CHEMICAL - SCIE ● CHEMISTRY, MULTIDISCIPLINARY - SCIE

## JOURNAL OF INDUSTRIAL AND ENGINEERING CHEMISTRY

[Export](#)

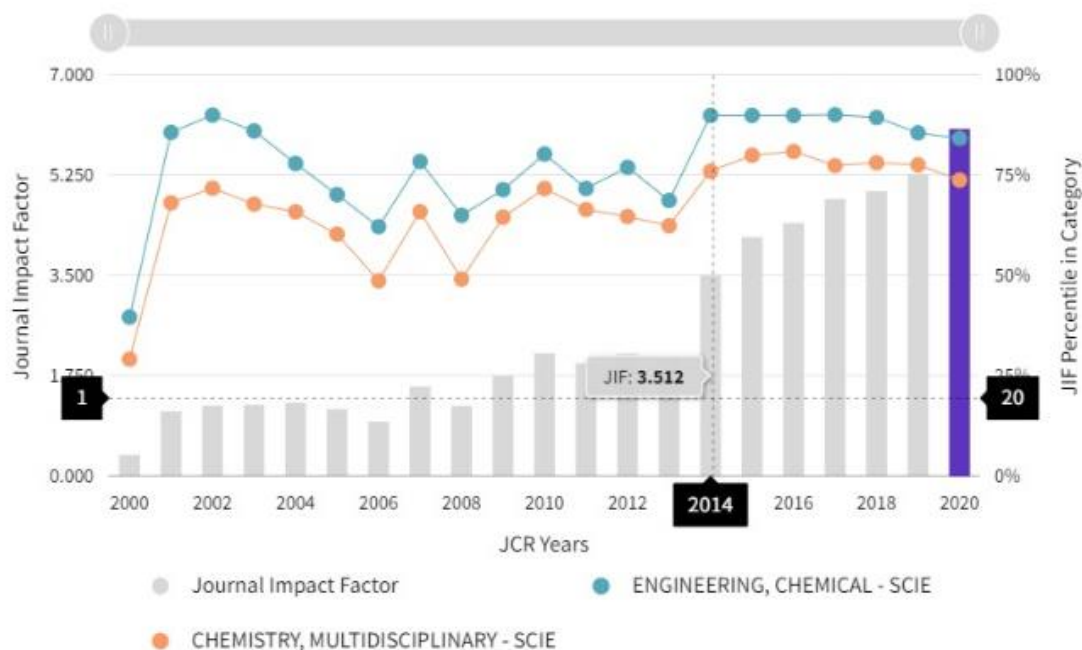

An overview of solar/visible light-driven heterogeneous p-TiO<sub>2</sub>- and ZnO-based photocatalysts used in suspension

## Journal Impact IF Trend



Journal of Industrial and Engineering Chemistry